



GR-1600XL

(Left-hand drive)

160 Ton (145 Metric Ton) Capacity

SPEC. SHEET NO. GR-1600-3-00103/ES-01

HYDRAULIC ROUGH TERRAIN CRANE

DIMENSIONS

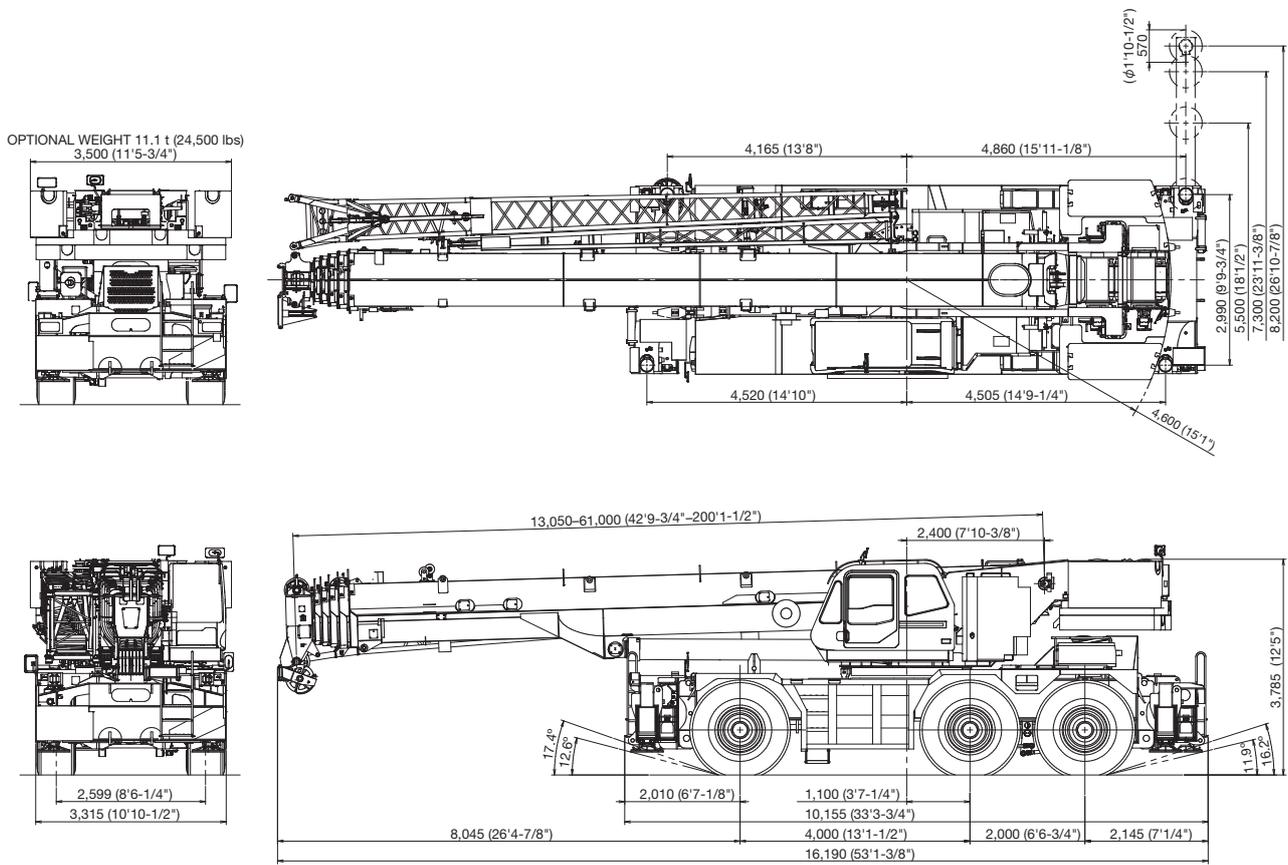

Note : Dimension is with boom angle at -1.5 degree.

GENERAL DIMENSIONS

	Meter	Feet
Turning radius (26.5R25☆☆ Tires)		
6 wheel steer	9.9	32' 6"
2 wheel steer	14.9	48' 11"

	Meter	Feet
Overall length	approx. 16,190	53' 1-3/8"
Overall width	approx. 3,315	10' 10-1/2"
Overall height	approx. 3,785	12' 5"
Carrier length for traveling	approx. 8,260	27' 1-1/4"

CRANE SPECIFICATIONS

BOOM

6 sections boom of round box construction with 7 sheaves at boom head, extended by single telescoping cylinder.
2 easily removable wire rope guards, rope dead end provided on both sides of boom head. Boom telescope sections are supported by wear pads both vertically and horizontally.

Fully retracted length..... 13.1 m (42.8')
Fully extended length..... 61.0 m (200.1')
Extension speed..... 47.9 m (157.3') in 450 s
Sheave root diameter..... 0.400 m (15-3/4")

BOOM ELEVATION

By a double acting hydraulic cylinder with holding valve.
Boom angle indicator.

Automatic speed reduction and slow stop function.
Boom angle -1.5–81.5°
Boom raising speed 20° to 60° in 28 s

JIB

2 stage bi-fold lattice type, 0°, 20° or 40° offset.
Single sheave at the head of both jib sections. Stowed alongside base boom section. Assistant cylinders for mounting and stowing, controlled at right side of superstructure.
Self stowing jib mounting pins.

Length 10.3 m, 18.0 m (33.8', 59.1')
Offset..... 0°, 20°, 40°
Sheave root diameter..... 0.440 m (17-5/16")

INSERT JIB (OPTION)

Insert lattice jib can be used for reaching higher place.
Length 7.0 m (1 pce.), 14.0 m (2 pcs.), (23.0', 45.9')

SHORT JIB (OPTION)

2 sheaves, heavy lifting jib can be used for lifting heavy load in tight spaces.

Length 3.6 m (11.8')
Offset..... 20°, 40°
Sheave root diameter..... 0.419 m (16-1/2")

AUXILIARY LIFTING SHEAVE (SINGLE TOP)

Single sheave, mounted to main boom head for single line work (stowable).

Root diameter..... 0.440 m (17-5/16")

ANTI-TWO BLOCK DEVICE

Pendant type over-winding cut out device with audio-visual (FAILURE lamp/BUZZER) warning system.

SLEWING

Hydraulic axial piston motor driven through planetary slewing speed reducer. Continuous 360° full circle slewing on ball bearing turn table at 1.3min⁻¹ {rpm}. Equipped with manually locked/released slewing brake. A 360° positive swing lock manually engaged in cab. Twin slewing system: Free slewing or lock slewing controlled by selector switch on front console.

Slewing speed..... 1.3 min⁻¹ {rpm}

COUNTERWEIGHT

Standard weight 18,200 kg (40,100 lbs)
Extra weight right (option) 5,550 kg (12,250 lbs)
Extra weight left (option)..... 5,550 kg (12,250 lbs)

WINCH

MAIN WINCH

Variable speed type with grooved drum driven by hydraulic axial piston motor through speed reducer. Power load lowering and raising. Equipped with automatic brake (neutral brake) and counterbalance valve. Controlled independently of auxiliary winch. Equipped with cable follower and drum rotation indicator.

MAIN DRUM

Root diameter x wide 0.382 m (15") x 0.742 m (29-1/4")
Wire rope diameter x length 19 mm (3/4") x 320 m (1,050')
Drum capacity 394 m (1293'), 7 layers
Maximum single line pull (1st layer)..... 9,900 kg (21,800 lbs)
Maximum permissible linepull wire strength... 7,200 kg (15,900 lbs)

AUXILIARY WINCH

Variable speed type with grooved drum driven by hydraulic axial piston motor through speed reducer.
Power load lowering and raising. Equipped with automatic brake (neutral brake) and counterbalance valve. Controlled independently of main winch. Equipped with cable follower and drum rotation indicator.

AUXILIARY DRUM

Root diameter x wide 0.382 m (15") x 0.742 m (29-1/4")
Wire rope diameter x length 19 mm (3/4") x 225 m (738')
Drum capacity 394 m (1293'), 7 layers
Maximum single line pull (1st layer)..... 9,900 kg (21,800 lbs)
Maximum permissible linepull wire strength... 7,200 kg (15,900 lbs)

WIRE ROPE

Non-rotating 19 mm (3/4") 7x35 class.
Breaking Strength 36,000 kg (79,400 lbs)

HOOK BLOCKS

100 metric ton (110 ton, option).... 7 sheaves with hook block and safety latch.
45 metric ton (50 ton, option)..... 3 sheaves with hook block and safety latch.
7.2 metric ton (7.9 ton, option)..... Weighted hook with swivel and safety latch.

HYDRAULIC SYSTEM

PUMPS

2 variable piston pumps for crane functions.
Tandem gear pump for steering, swing and optional equipment.
Powered by carrier engine. Pump disconnect for crane is engaged/ disengaged by rotary switch from operator's cab.

CONTROL VALVES

Multiple valves actuated by pilot pressure with integral pressure relief valves.

RESERVOIR

763 lit. (202 gallon) capacity. External sight level gauge.

FILTRATION

BETA10=10 return filter, full flow with bypass protection, located inside of hydraulic reservoir. Accessible for easy replacement.

OIL COOLER

Air cooled fan type.

CAB AND CONTROLS

Both crane and drive operations can be performed from one cab mounted on rotating superstructure.

15° tilt, Left side, 1 man type, steel construction with sliding door access and safety glass windows opening at side. Door window is powered control. Windshield glass window and roof glass window are shatter-resistant. Tilt-telescoping steering wheel. Adjustable control lever stands for swing, boom elevating, boom telescoping, auxiliary winch and main winch. Control lever stands can change neutral positions and tilt for easy access to cab. 3 way adjustable operator's seat with high back, headrest and armrest. Engine throttle knob. Foot operated controls: boom elevating boom telescoping, service brake and engine throttle. Hot water cab heater and air conditioning.

Dash-mounted engine start/stop, monitor lamps, cigarette lighter, drive selector switch, parking brake switch, steering mode select switch, power window switch, pump engaged/ disengaged switch, swing brake switch, telescoping/auxiliary winch select switch, outrigger controls, free swing / lock swing selector switch, eco mode switch, high speed winch (main/aux) switch and ashtray.

Instruments - Torque converter oil temperature, engine water temperature, air pressure, fuel, speedometer, tachometer, hour meter and odometer / tripmeter. Hydraulic oil pressure is monitored and displayed on the AML-C display panel.

CRANE SPECIFICATIONS

Tadano electronic LOAD MOMENT INDICATOR system (AML-C) including:

- Control lever lockout function with audible and visual pre-warning
- Boom position indicator
- Outrigger state indicator
- Boom angle / boom length / jib offset angle / jib length / load radius / rated lifting capacities / actual loads read out
- Ratio of actual load moment to rated load moment indication
- Automatic speed reduction and slow stop function on boom elevation and slewing
- Working condition register switch
- Load radius / boom angle / tip height / slewing range preset function
- External warning lamp
- Tare function
- Fuel consumption monitor
- Main winch / auxiliary winch select
- Drum rotation indicator (audible and visible type) main and auxiliary winch

TADANO AML-C monitors outrigger extended length and automatically programs the corresponding "RATED LIFTING CAPACITIES" table.

Operator's right hand console includes transmission gear selector and sight level bubble. Upper console includes working light switch, roof washer and wiper switch emergency outrigger set up key switch, jib equipped/removed select switch, eco mode switch, high speed winch (main / aux) switch, Cab tilt switch. Slewing lock lever.

NOTE: Each crane motion speed is based on unladen conditions.

CARRIER SPECIFICATIONS

TYPE

Rear engine, left hand steering, driving axle 2-way selected type by manual switch, 6x2 1st drive, 6x4 1st and 3rd drive.

FRAME

High tensile steel, all welded mono-box construction.

ENGINE

Model	MITSUBISHI 6M60-TL (Tier2)
Type	Direct injection diesel
No. of cylinders	6
Combustion	4 cycle, turbo charged and after cooled
Bore x Stroke, mm. (in)	118 x 115 (4.646 x 4.528)
Displacement, liters (cu. in)	7.54 (460)
Air inlet heater	24 volt preheat
Air cleaner	Dry type, replaceable element
Oil filter	Full flow with replaceable element
Fuel filter	Full flow with replaceable element
Fuel tank, liters (gal.)	300 (79.2), right side of carrier
Cooling	Liquid pressurized, recirculating by-pass
Radiator	Fin and tube core, thermostat controlled
Fan, mm (in.)	Suction type, 6-blade, 600 (23.6) dia.
Starting	24 volt
Charging	24 volt system, negative ground
Battery	2-120 amp. Hour
Compressor, air, l/min (CFM)	830 (29) at 2,600 rpm
Output, Max. kW (HP)	Gross 200 (267) at 2,600 rpm
Torque, Max. Nm (ft-lb)	785 (579) at 1,400 rpm
Capacity, liters (gal.)	
Cooling water	13 (3.4)
Lubrication	13-15 (3.4-4.0)
Fuel	300 (79.2)

TRANSMISSION

Electronically controlled full automatic transmission. Torque converter driving full powershift with driving axle selector. 5 forward and 2 reverse speeds, constant mesh.

- 2 speeds - high range - 2 wheel drive; 4 wheel drive
- 3 speeds - low range - 4 wheel drive

TRAVEL SPEED

15 km/h (9.3 mph) with counterweight
4 km/h (2.5 mph) without counterweight

GRADE ABILITY (tan θ) - 44% (with counterweight 29.3 t (64,600 lbs)), 52% (with counterweight 18.2 t (40,100 lbs)), 30%*

* Machine should be operated within the limit of engine crankcase design (17°: MITSUBISHI 6M60-TL).

AXLE

1st: Full floating type, steering and driving axle with planetary reduction and open differential.
2nd: Steering and not driving axle.
3rd: Full floating type, steering and driving axle with planetary reduction and open differential.

STEERING

Hydraulic power steering controlled by steering wheel. Four steering modes available: 2 wheel front, 4 wheel rear, 6 wheel coordinated and 6 wheel crab.

SUSPENSION

1st: Rigid mounted to frame.
2nd and 3rd: "Hydro-Pneumatic suspension cylinders" with levering adjustment and oscillation.

BRAKE SYSTEMS

Service: Air over hydraulic disc brakes on all 6 wheels. Parking/Emergency: Spring applied-air released brake acting on input shaft of 1st and 3rd axle.
Auxiliary: Electro-pneumatic operated exhaust brake.

TIRES - 26.5R25☆☆ Air pressure: 650 kPa (94 psi)

OUTRIGGERS

Four hydraulic, beam and jack outriggers. Vertical jack cylinders equipped with integral holding valve. Each outrigger beam and jack is controlled independently from cab. Beams extend to 8.2 m (26'10-7/8") center-line and retract to within 3.315 m (10' 10-1/2") overall width with floats. Outrigger boxes are self-removable for ease of transportation. Outrigger jack floats are attached thus eliminating the need of manually attaching and detaching them. Controls and sight bubble located in superstructure cab. Four outrigger extension lengths are provided with corresponding "RATED LIFTING CAPACITIES" for crane duty in confined areas.

Min. Extension	2.99 m (9' 9-3/4") center to center
Mid. Extension	5.50 m (18' 1/2") center to center
Mid. Extension	7.30 m (23'11-3/8") center to center
Max. Extension	8.20 m (26'10-7/8") center to center
Float size (Diameter)	0.57 m (1'10-1/2")

STANDARD EQUIPMENT

- Six section extended boom by single telescoping cylinder 13.1 m–61.0 m (42.8'–200.1')
- 10.3 m (33.8') or 18.0 m (59.1') bi-fold lattice jib with 0°, 20° or 40° pinned offsets and self stowing pins.
- Quick reeving type bi-fold jib
- Anti-Two block device (overwind cutout)
- Mirror for main and auxiliary winch
- Work lights
- Variable speed main winch with grooved drum, cable follower and 320 m of 19 mm (1050' of 3/4") cable.
- Variable speed auxiliary winch with grooved drum, cable follower and 225 m of 19 mm (738' of 3/4") cable.
- Drum rotation indicator (audible, visible and thumper type) main and auxiliary winch
- Auxiliary lifting sheave (single top) stowable
- 2-speed winch
- Tadano twin swing system and 360° positive swing lock
- Positive control
- Hydraulic oil cooler
- 15° tilt cab
- 3 way adjustable cloth seat with armrests, high back and seat belt
- Tilt-telescoping steering wheel
- Tinted safety glass and sun visor
- Front windshield wiper and washer
- Roof window wiper and washer
- Power window (cab door)
- Cigarette lighter and ashtray
- Cab floor mat
- Pump disconnect in operator's cab
- Air conditioner (hot water heater and cooler)
- Full instrumentation package
- Self centering finger control levers with pilot control
- Control pedals for boom elevating and boom telescoping
- Low oil pressure/high water temp. warning device (visual)
- 2nd and 3rd steer centering light
- Air cleaner dust indicator
- Tadano electronic load moment indicator system (AML-C)
- Tare function
- Boom angle indicator
- Outrigger extension length detector
- Electronic crane monitoring system
- Rear view mirrors (right and left side)
- Fenders
- Air dryer
- Complete highway light package
- Towing hooks-Front and rear
- Hook block tie down (front bumper)
- Weighted hook storage compartment
- Halogen head lamp
- Self-removable outrigger boxes
- Independently controlled outriggers
- Four outrigger extension positions
- Self-storing outrigger pads
- Electronic controlled automatic transmission driven by torque converter
- 6 x 4 x 6 drive/steer
- 1st axle: open differential
- 3rd axle: open differential
- Automatic rear axle oscillation lockout system
- 26.5R25☆☆ tires
- Disc brakes
- Water separator with filter (high filtration)
- Back-up alarm
- 24 volt electric system
- Tool storage compartment
- Tire inflation kit
- Mitsubishi 6M60-TLA3B turbo charged after cooled engin (267HP) with exhaust brake
- Engine over-run alarm
- Lifting eyes
- Fuel consumption monitor
- Eco mode system
- Self-removable counterweight

OPTIONAL EQUIPMENT

- Additional weight 11.1 t (24,500 lbs)
- Removable boom system
- Working lamp with remote controller
- Boom and jib mounted aircraft warning light
- Wind speed indicator
- Emergency steering system
- Over-unwinding prevention
- Insert jib
- Short jib
- 100 metric ton (110 ton) - 7 sheaves with hook block and safety latch
- 45 metric ton (50 ton) - 3 sheaves with hook block and safety latch
- 7.2 metric ton (7.9 ton) - Weighted hook with swivel and safety latch
- Telematics(machine data logging and monitoring system) with HELLO-NET via internet (availability depends on countries)
- Outrigger load display and warning
- Inclinator (electronic inclination indicator)

HOISTING PERFORMANCE

LINE SPEEDS AND PULLS

Layer	Main or auxiliary winch - 0.382 m (15") drum					
	Line speeds ¹				Line pulls Available ²	
	Low		High		Low	
	m/min	F.P.M	m/min	F.P.M	kgf	Lbs.
1st	77	253	108	354	9,900	21,800
2nd	84	276	117	384	9,010	19,900
3rd	91	299	126	413	8,270	18,200
4th	97	318	136	446	7,640	16,800
5th	104	341	145	476	7,090	15,600
6th	110	361	154	505	6,620	14,600
7th ³	117	384	163	535	6,210	13,700

- Maximum permissible line pull wire strength.
7,200 kg (15,900 lbs) with 7 x 35 class rope.

¹ Line speed based only on hook block, not loaded.

² Developed by machinery with each layer of wire rope, but not based on rope strength or other limitations in machinery or equipment.

³ Seventh layer of wire rope are not recommended for hoisting operations.

DRUM WIRE ROPE CAPACITIES

Wire rope layer	Main and auxiliary drum grooved lagging			
	19 mm (3/4") wire rope			
	Rope per layer		Total wire rope	
	Meter	Feet	Meter	Feet
1	44.8	147.0	44.8	147.0
2	48.6	159.4	93.4	306.4
3	52.5	172.2	145.9	478.7
4	56.3	184.7	202.2	663.4
5	60.1	197.2	262.3	860.6
6	63.9	209.6	326.2	1070.2
7	67.7	222.1	393.9	1292.3

DRUM DIMENSIONS (Main and auxiliary)

	mm	Inch
Root diameter	382	15
Length	742	29-1/4
Flange diameter	677	26-5/8

GR-1600XL WORKING RANGE CHART

Manual offset jib
Counterweight 29.3 t

BOOM

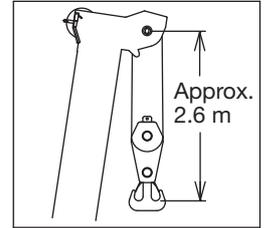

JIB

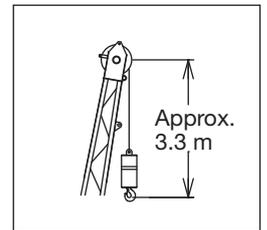

SINGLE TOP

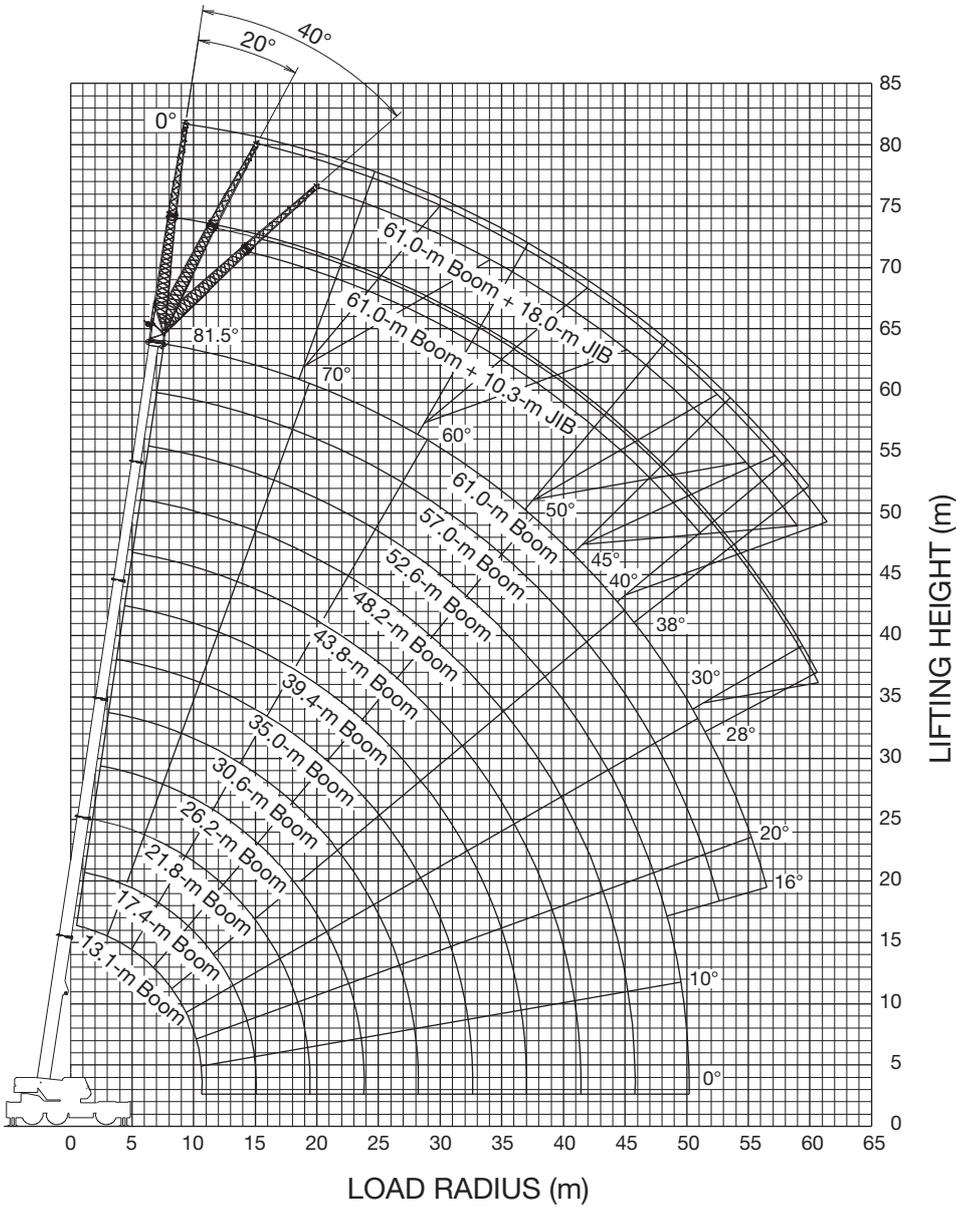
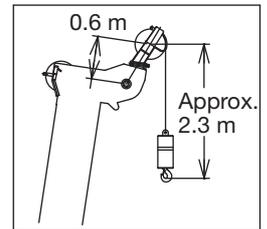

NOTE: Boom and jib geometry shown are for unloaded condition and machine standing level on firm supporting surface. Boom deflection and subsequent radius and boom angle change must be accounted for when applying load to hook.

GR-1600XL WORKING RANGE CHART

Manual offset jib
7.0 m Insert jib *Option
Counterweight 29.3 t

BOOM

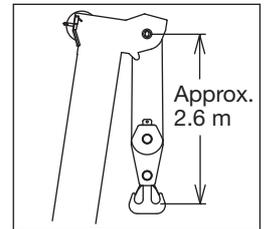

JIB

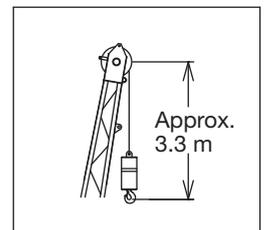

SINGLE TOP

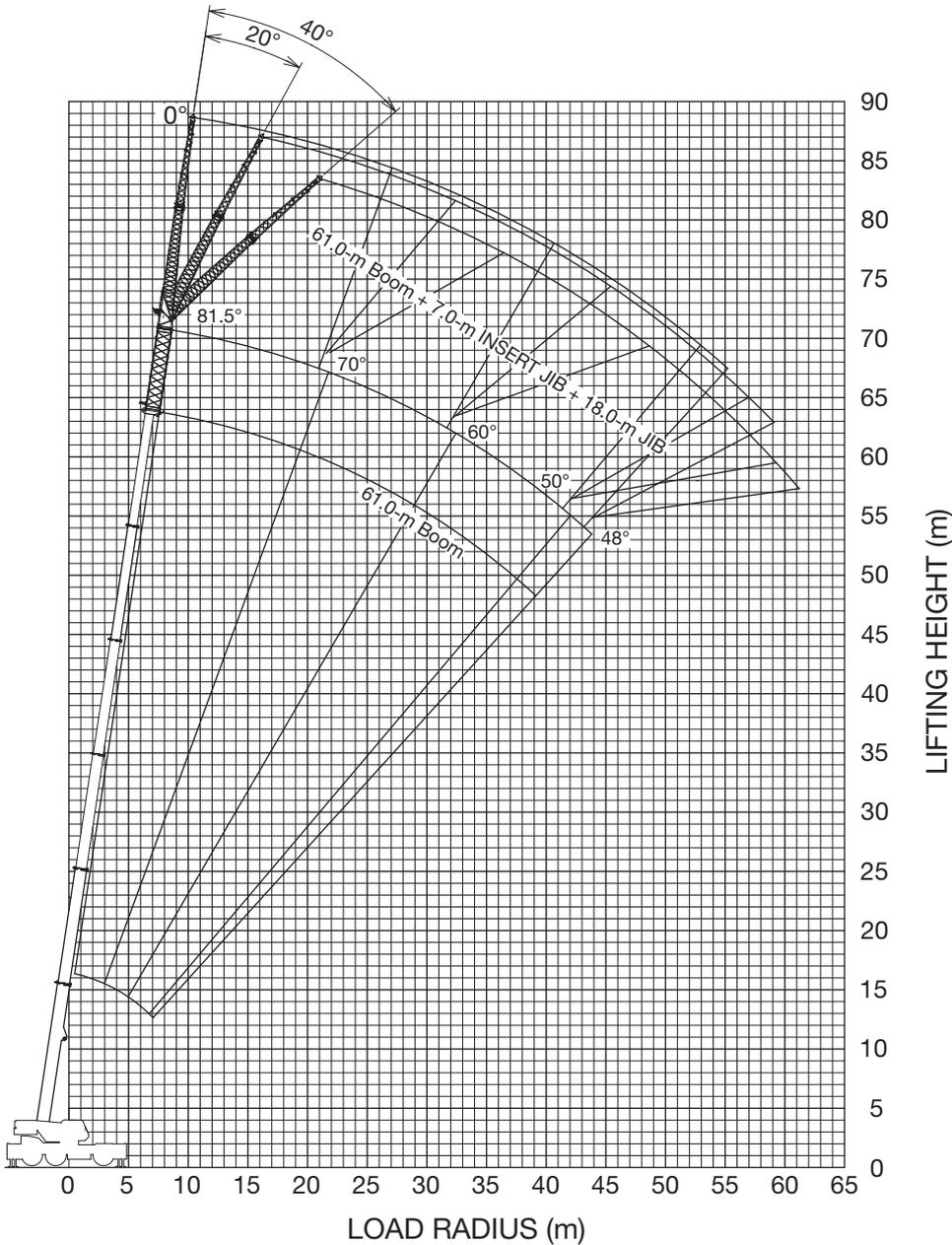
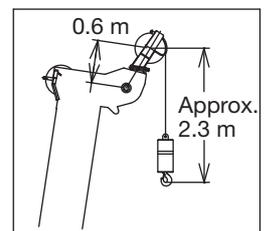

NOTE: Boom and jib geometry shown are for unloaded condition and machine standing level on firm supporting surface. Boom deflection and subsequent radius and boom angle change must be accounted for when applying load to hook.

GR-1600XL WORKING RANGE CHART

Manual offset jib
14.0 m Insert jib *Option
Counterweight 29.3 t

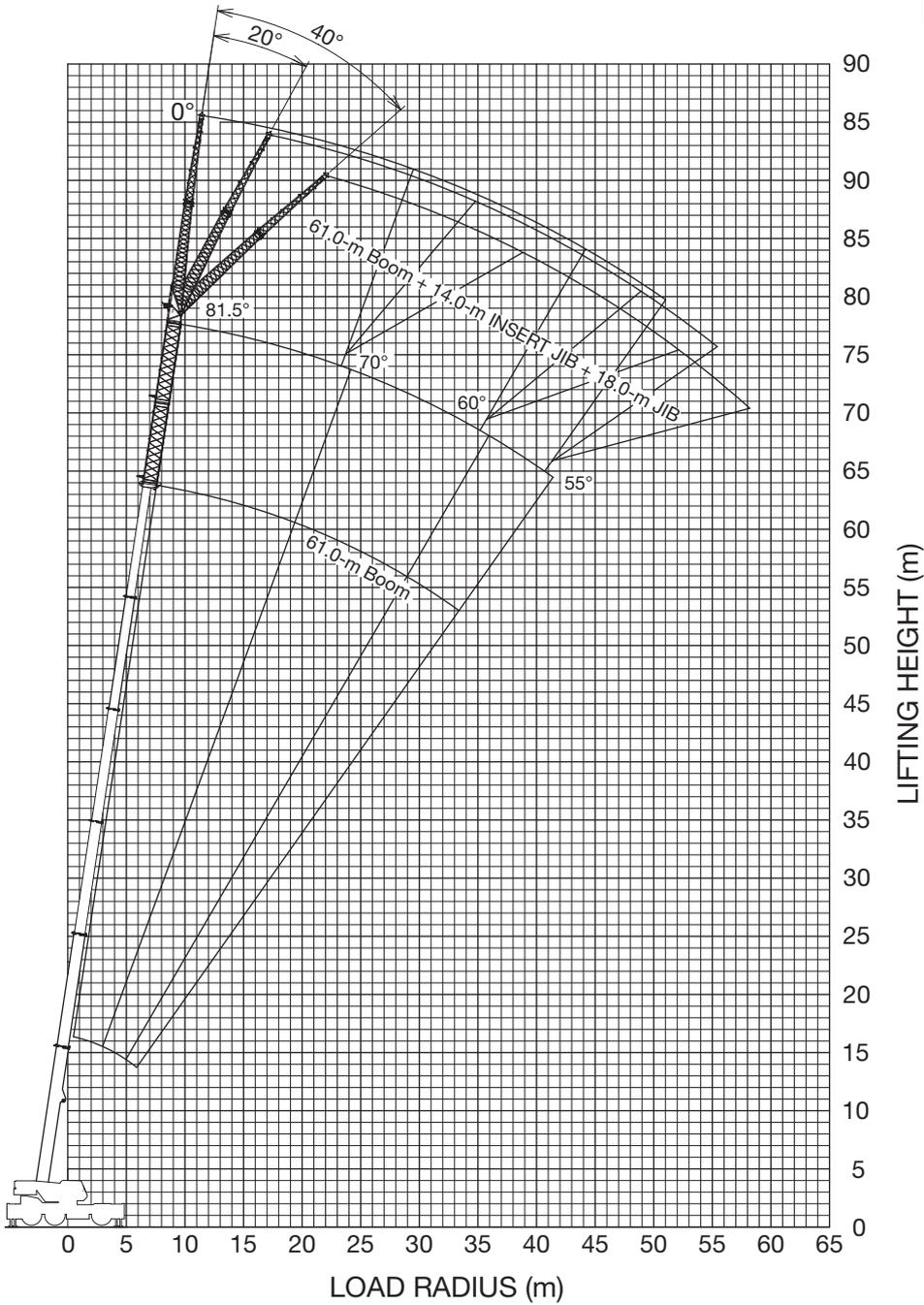

BOOM

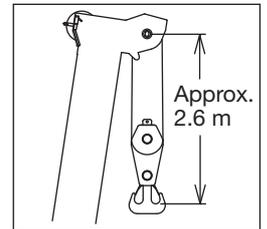

JIB

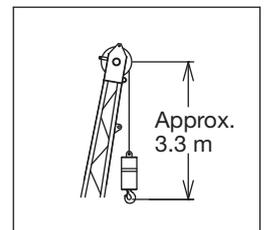

SINGLE TOP

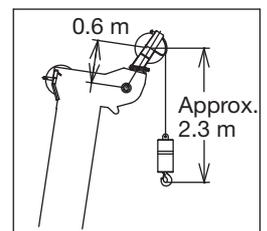

NOTE: Boom and jib geometry shown are for unloaded condition and machine standing level on firm supporting surface. Boom deflection and subsequent radius and boom angle change must be accounted for when applying load to hook.

GR-1600XL WORKING RANGE CHART

Short jib *Option
Counterweight 29.3 t

BOOM

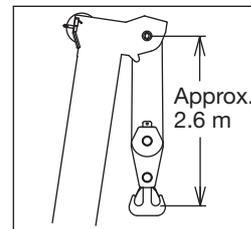

JIB

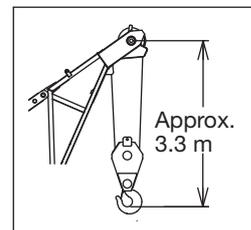

SINGLE TOP

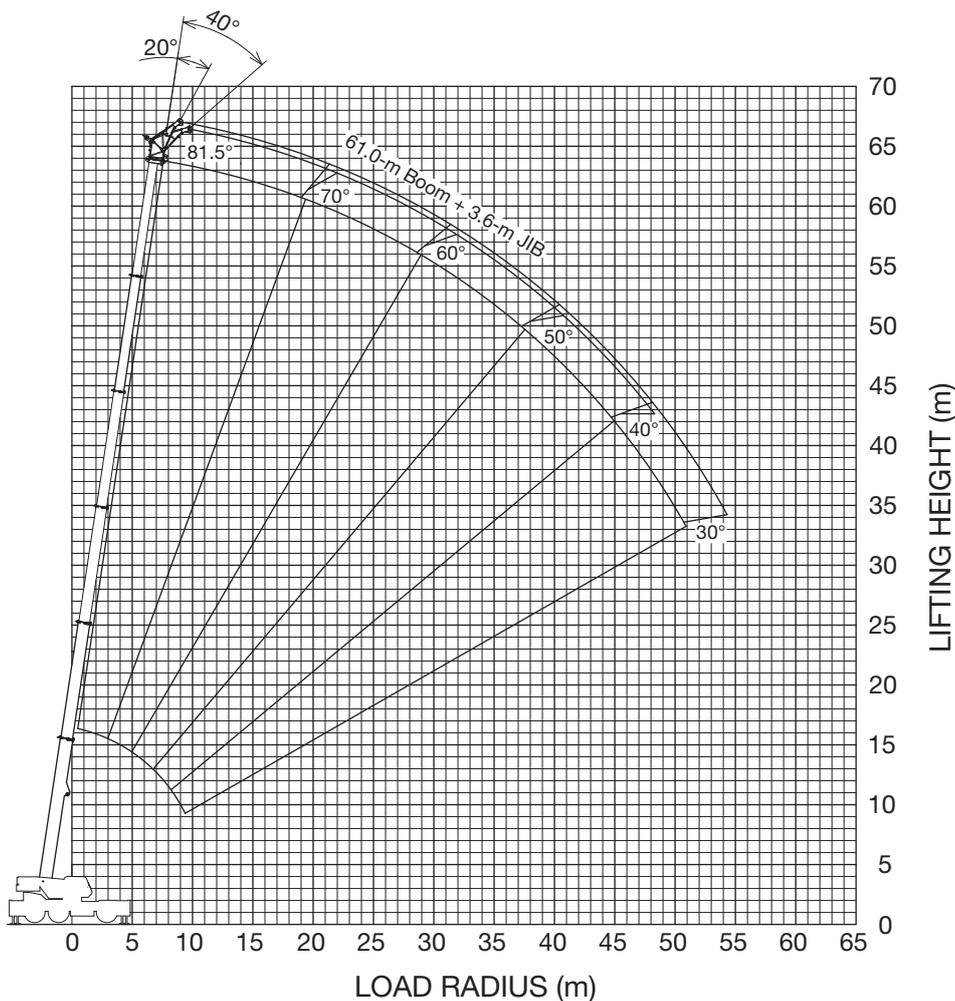
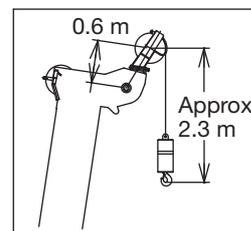

NOTE: Boom and jib geometry shown are for unloaded condition and machine standing level on firm supporting surface. Boom deflection and subsequent radius and boom angle change must be accounted for when applying load to hook.

GR-1600XL RATED LIFTING CAPACITIES (IN METRIC TON)

Boom

COUNTERWEIGHT 29.3 t (64,600 lbs) ON OUTRIGGERS FULLY EXTENDED 8.2 m (26'10-7/8") SPREAD 360° ROTATION (Unit: x 1,000 kg)												
A \ B	13.1 m (42.8')	17.4 m (57.2')	21.8 m (71.6')	26.2 m (86.1')	30.6 m (100.5')	35.0 m (114.9')	39.4 m (129.3')	43.8 m (143.7')	48.2 m (158.1')	52.6 m (172.5')	57.0 m (187.0')	61.0 m (200.1')
2.50	**145.0	90.7	79.0									
3.00	*110.6	90.7	79.0	37.0								
3.50	*101.5	90.7	79.0	66.0								
4.00	93.6	90.1	79.0	66.0	37.0							
4.50	85.9	83.7	79.0	66.0	48.2							
5.00	79.3	78.1	75.8	66.0	48.2	35.2						
5.50	73.5	73.2	71.0	66.0	48.2	35.2						
6.00	68.3	68.3	66.7	63.5	48.2	38.7						
6.50	63.7	64.1	63.6	60.5	48.2	37.5	30.1					
7.00	59.6	60.0	60.2	57.8	48.2	35.9	30.1					
7.50	56.0	56.4	56.5	55.3	48.2	35.2	30.1	22.1				
8.00	52.7	53.1	53.2	52.9	48.0	35.2	29.5	23.9				
9.00	46.8	47.3	47.5	47.2	44.8	35.2	27.9	23.9	17.2			
10.00	37.3	41.7	41.9	41.6	41.6	35.2	26.2	22.9	18.9	13.5		
11.00		37.1	37.3	37.5	37.7	33.2	24.4	22.0	18.9	15.0		
12.00		33.4	33.5	34.3	33.9	31.5	22.7	21.0	18.4	15.0	12.0	
14.00		27.8	27.6	28.4	28.0	28.4	20.9	19.2	16.9	15.0	12.0	10.4
16.00			23.3	24.0	24.3	24.3	19.3	17.1	15.5	14.1	12.0	10.4
18.00			21.3	20.6	21.3	20.9	17.8	15.4	14.3	13.1	12.0	10.4
20.00				18.4	18.5	18.1	16.5	14.0	12.9	12.1	11.2	10.2
22.00				16.3	16.1	15.7	15.4	12.7	11.8	11.2	10.4	9.6
24.00					14.1	13.6	14.1	11.7	10.8	10.4	9.8	9.0
26.00					12.3	12.8	12.3	10.8	10.1	9.6	9.1	8.4
28.00					8.2	11.4	10.8	10.0	9.4	8.8	8.5	7.8
30.00						10.1	9.6	9.2	8.8	8.2	8.0	7.3
32.00						8.4	8.5	8.6	8.2	7.7	7.4	6.7
34.00							7.6	7.9	7.4	7.3	7.0	6.2
36.00							6.8	7.1	6.6	6.9	6.5	5.8
38.00								6.4	6.1	6.3	5.8	5.4
40.00								5.8	5.8	5.6	5.2	5.0
42.00									5.3	5.0	4.6	4.6
44.00									4.8	4.5	4.1	4.1
46.00										4.1	3.7	3.6
48.00										3.7	3.2	3.2
50.00										2.8	2.8	2.8
52.00											2.5	2.4
54.00											2.2	2.1
56.00												1.8

**Over front with special equipment

*With special Equipment

A: Boom length (m)

B: Load radius (m)

NOTE: In this table, the thick line which divides strength area and stability area is not shown because the figure of this table is indicated the best performance at the same boom length among the plural telescopic boom patterns.

GR-1600XL RATED LIFTING CAPACITIES (IN METRIC TON)

Jib

COUNTERWEIGHT 29.3 t (64,600 lbs) ON OUTRIGGERS FULLY EXTENDED 8.2 m (26'10-7/8") SPREAD 360° ROTATION													
C	61.0-m (200.1') Boom + 10.3-m (33.8') Manual offset jib						C	57.0-m (187.0') Boom + 10.3-m (33.8') Manual offset jib					
	0° Tilt		20° Tilt		40° Tilt			0° Tilt		20° Tilt		40° Tilt	
	R	W	R	W	R	W		R	W	R	W	R	W
81.5	13.2	5.5	17.3	5.5	20.3	5.2	81.5	11.8	6.2	15.7	6.2	18.6	5.8
81	13.9	5.5	18.1	5.5	21.0	5.1	81	12.5	6.2	16.5	6.2	19.2	5.8
80	15.9	5.5	19.7	5.4	22.4	4.9	80	14.0	6.2	18.0	6.2	20.5	5.6
79	17.2	5.5	21.3	5.3	23.7	4.8	79	15.5	6.2	19.2	6.0	21.7	5.4
78	18.8	5.5	22.5	5.1	25.1	4.7	78	16.9	6.2	20.5	5.8	22.9	5.3
77	20.3	5.5	23.8	4.9	26.3	4.5	77	18.4	6.2	21.8	5.6	24.1	5.1
76	21.9	5.5	25.3	4.8	27.6	4.4	76	19.8	6.2	23.1	5.5	25.3	5.0
75	23.3	5.3	26.6	4.7	28.8	4.3	75	21.1	6.1	24.3	5.3	26.5	4.9
73	26.1	5.0	29.2	4.4	31.2	4.1	73	23.6	5.7	26.7	5.0	28.7	4.6
70	29.8	4.5	32.9	4.1	34.6	3.8	70	27.2	5.2	30.1	4.6	31.9	4.3
68	32.3	4.3	35.2	3.9	36.8	3.6	68	29.4	4.9	32.4	4.4	34.0	4.1
65	35.9	4.0	38.6	3.6	39.9	3.4	65	32.7	4.5	35.6	4.1	37.0	3.9
63	38.0	3.7	40.8	3.5	42.0	3.3	63	35.0	4.3	37.5	3.9	38.9	3.7
60	41.3	3.4	43.7	3.2	45.0	3.1	60	38.0	4.0	40.5	3.7	41.8	3.6
58	43.4	3.2	45.8	3.0	46.7	2.9	58	40.1	3.9	42.5	3.6	43.4	3.4
55	46.4	3.0	48.6	2.8	49.4	2.7	55	42.9	3.6	45.2	3.4	46.1	3.3
53	48.2	2.8	50.4	2.7	51.1	2.6	53	44.6	3.4	46.9	3.3	47.6	3.2
50	50.8	2.5	52.7	2.4	53.2	2.3	50	47.2	3.2	49.1	3.0	49.8	3.0
48	52.3	2.3	54.2	2.2	54.7	2.2	48	48.8	3.0	50.7	2.9	51.1	2.8
45	54.7	2.1	56.4	2.0	56.7	2.0	45	51.0	2.7	52.7	2.6	53.0	2.6
43	56.1	1.9	57.8	1.9			43	52.4	2.6	54.0	2.5		
40	58.2	1.7	59.5	1.6			40	54.4	2.4	55.7	2.2		
38	59.4	1.5	60.6	1.4			38	55.5	2.1	56.8	2.0		
35	61.1	1.2	62.1	1.1			35	57.2	1.8	58.2	1.7		
33	62.2	1.1	63.0	1.0			33	58.3	1.7	59.2	1.6		
30	63.7	0.9	64.3	0.8			30	59.8	1.5	60.4	1.4		
28	64.6	0.8					28	60.6	1.3	61.1	1.3		
25							25	61.8	1.2	62.0	1.1		
23							23	62.4	1.1				
20							20	63.3	1.0				
G				1			G				1		

COUNTERWEIGHT 29.3 t (64,600 lbs) ON OUTRIGGERS FULLY EXTENDED 8.2 m (26'10-7/8") SPREAD 360° ROTATION													
C	52.6-m (172.5') Boom + 10.3-m (33.8') Manual offset jib						C	35.0-m (114.9') Boom + 10.3-m (33.8') Manual offset jib					
	0° Tilt		20° Tilt		40° Tilt			0° Tilt		20° Tilt		40° Tilt	
	R	W	R	W	R	W		R	W	R	W	R	W
81.5	10.3	7.2	14.3	7.2	17.3	6.8	81.5			8.9	10.6	11.3	7.3
81	10.9	7.2	14.9	7.2	17.9	6.7	81			9.3	10.5	11.7	7.2
80	12.3	7.2	16.3	7.2	19.1	6.5	80			10.1	10.2	12.5	7.1
79	13.7	7.2	17.6	7.1	20.2	6.3	79			10.9	10.0	13.2	7.0
78	15.0	7.2	18.8	6.9	21.4	6.1	78			11.9	9.7	14.0	6.9
77	16.4	7.2	19.7	6.6	22.5	6.0	77			12.6	9.5	14.8	6.9
76	17.6	7.2	21.1	6.4	23.5	5.8	76			13.3	9.3	15.5	6.8
75	19.0	7.2	22.2	6.2	24.6	5.7	75	11.3	14.1	14.1	9.1	16.2	6.7
73	21.3	6.8	24.4	5.9	26.7	5.4	73	12.9	13.2	15.6	8.7	17.6	6.5
70	24.8	6.2	27.7	5.4	29.6	5.0	70	15.2	12.2	17.9	8.2	19.6	6.3
68	26.9	5.9	29.7	5.2	31.5	4.8	68	16.7	11.6	19.3	7.9	21.0	6.2
65	30.1	5.4	32.7	4.9	34.3	4.6	65	18.9	10.8	21.4	7.6	22.9	6.1
63	32.1	5.2	34.6	4.7	36.0	4.4	63	20.3	10.4	22.8	7.4	24.2	6.0
60	35.0	4.8	37.4	4.4	38.7	4.2	60	22.4	9.9	24.8	7.1	26.0	5.9
58	36.8	4.5	39.2	4.2	40.4	4.1	58	23.7	9.6	26.0	6.9	27.2	5.8
55	39.5	4.2	41.6	4.0	42.6	3.8	55	25.7	9.1	27.8	6.7	28.9	5.8
53	41.1	4.0	43.2	3.8	44.1	3.7	53	26.8	8.7	29.0	6.5	29.9	5.7
50	43.6	3.8	45.5	3.6	46.2	3.5	50	28.6	8.3	30.6	6.4	31.5	5.7
48	45.0	3.6	46.8	3.4	47.4	3.3	48	29.7	8.0	31.7	6.3	32.4	5.7
45	47.2	3.3	48.8	3.1	49.2	3.1	45	31.4	7.7	33.2	6.1	33.8	5.6
43	48.5	3.1	50.0	3.0			43	32.4	7.5	34.1	6.1		
40	50.4	2.9	51.7	2.7			40	33.9	7.2	35.5	6.0		
38	51.5	2.6	52.7	2.5			38	34.9	7.0	36.3	5.9		
35	53.1	2.3	54.1	2.2			35	36.2	6.8	37.5	5.9		
33	54.1	2.1	55.0	2.0			33	37.0	6.7	38.2	5.8		
30	55.5	1.9	56.3	1.8			30	38.1	6.4	39.1	5.8		
28	56.3	1.7	56.9	1.6			28	38.8	6.2	39.7	5.8		
25	57.4	1.5	57.8	1.5			25	39.8	5.9	40.4	5.7		
23	58.1	1.4					23	40.3	5.7				
20	58.9	1.3					20	41.1	5.5				
G				1			G				2		

C: Loaded boom angle (°)
 R: Load radius (m)
 W: Rated lifting capacity (Unit: x 1,000 kg)
 G: Number of parts of line

GR-1600XL RATED LIFTING CAPACITIES (IN METRIC TON)

Jib

COUNTERWEIGHT 29.3 t (64,600 lbs) ON OUTRIGGERS FULLY EXTENDED 8.2 m (26'10-7/8") SPREAD 360° ROTATION													
C	61.0-m (200.1') Boom + 18.0-m (59.1') Manual offset jib						C	57.0-m (187.0') Boom + 18.0-m (59.1') Manual offset jib					
	0° Tilt		20° Tilt		40° Tilt			0° Tilt		20° Tilt		40° Tilt	
	R	W	R	W	R	W		R	W	R	W	R	W
81.5	15.1	3.7	22.4	3.7	27.2	3.2	81.5	13.3	4.0	20.2	4.0	24.8	3.3
81	16.1	3.7	23.0	3.7	28.2	3.2	81	14.1	4.0	21.1	4.0	25.6	3.3
80	17.7	3.7	25.0	3.7	29.6	3.1	80	15.7	4.0	22.7	4.0	27.1	3.3
79	19.6	3.7	26.7	3.7	31.2	3.1	79	17.3	4.0	24.2	3.9	28.3	3.2
78	21.5	3.7	28.3	3.6	32.6	3.0	78	19.0	4.0	25.7	3.8	29.8	3.2
77	23.0	3.7	29.8	3.5	34.0	3.0	77	20.6	4.0	27.1	3.7	31.0	3.1
76	24.9	3.7	31.4	3.4	35.4	3.0	76	22.2	4.0	28.6	3.7	32.4	3.1
75	26.6	3.7	32.7	3.3	36.6	2.9	75	23.8	4.0	30.0	3.6	33.6	3.1
73	29.7	3.7	35.5	3.1	39.3	2.9	73	26.9	4.0	32.7	3.5	36.0	3.0
70	33.9	3.4	39.3	2.9	42.8	2.7	70	31.3	4.0	36.6	3.3	39.5	2.9
68	36.7	3.3	41.9	2.8	45.1	2.6	68	34.0	3.8	39.1	3.2	41.6	2.8
65	40.6	3.0	45.6	2.6	48.2	2.4	65	37.7	3.5	42.5	3.0	44.8	2.8
63	43.3	2.9	47.9	2.5	50.5	2.4	63	40.2	3.4	44.7	2.9	46.8	2.7
60	46.8	2.6	51.3	2.4	53.3	2.2	60	43.6	3.1	48.0	2.8	49.8	2.6
58	49.2	2.5	53.3	2.2	55.3	2.2	58	45.9	3.0	50.0	2.7	51.5	2.5
55	52.4	2.3	56.3	2.1	57.8	2.0	55	49.0	2.8	52.8	2.5	54.1	2.4
53	54.3	2.1	58.0	1.9	59.2	1.8	53	50.9	2.6	54.6	2.4	55.6	2.3
50	56.9	1.8	60.3	1.6	61.3	1.6	50	53.6	2.4	57.0	2.2	57.6	2.1
48	58.8	1.6	61.9	1.5	62.5	1.5	48	55.3	2.2	58.4	2.0	58.9	2.0
45	61.2	1.4	64.0	1.3	64.4	1.2	45	57.7	2.0	60.5	1.8	60.6	1.7
43	62.8	1.3	65.3	1.1			43	59.1	1.8	61.8	1.7		
40	64.8	1.0	67.1	0.9			40	61.3	1.6	63.4	1.4		
38	66.3	0.9					38	62.5	1.4	64.6	1.2		
35							35	64.4	1.2	66.0	1.0		
33							33	65.4	1.0	66.9	0.9		
30							30	67.0	0.8				
28							28						
25							25						
23							23						
20							20						
G				1			G				1		

COUNTERWEIGHT 29.3 t (64,600 lbs) ON OUTRIGGERS FULLY EXTENDED 8.2 m (26'10-7/8") SPREAD 360° ROTATION													
C	52.6-m (172.5') Boom + 18.0-m (59.1') Manual offset jib						C	35.0-m (114.9') Boom + 18.0-m (59.1') Manual offset jib					
	0° Tilt		20° Tilt		40° Tilt			0° Tilt		20° Tilt		40° Tilt	
	R	W	R	W	R	W		R	W	R	W	R	W
81.5	12.0	4.7	18.7	4.4	23.2	3.4	81.5	7.4	6.4	13.3	5.4	18.0	3.7
81	12.8	4.7	19.4	4.4	23.8	3.4	81	8.0	6.4	13.7	5.3	18.4	3.7
80	14.3	4.7	20.9	4.3	25.3	3.4	80	9.0	6.4	14.7	5.2	19.3	3.6
79	15.9	4.7	22.2	4.2	26.5	3.3	79	10.2	6.4	15.7	5.1	20.1	3.6
78	17.3	4.7	23.5	4.1	27.7	3.3	78	11.1	6.4	16.6	5.0	20.9	3.6
77	18.8	4.7	24.9	4.0	28.9	3.3	77	12.1	6.4	17.5	4.8	21.7	3.5
76	20.1	4.7	26.2	3.9	30.1	3.2	76	13.0	6.4	18.5	4.7	22.5	3.5
75	21.7	4.7	27.5	3.9	31.2	3.2	75	14.0	6.4	19.3	4.6	23.4	3.5
73	24.7	4.7	30.0	3.7	33.4	3.1	73	15.8	6.4	21.2	4.5	24.9	3.4
70	28.7	4.7	33.7	3.6	36.7	3.0	70	18.7	6.3	22.7	4.2	27.1	3.3
68	31.2	4.5	36.1	3.5	38.8	3.0	68	20.3	6.0	25.4	4.1	28.5	3.2
65	34.8	4.2	39.4	3.3	41.6	2.9	65	22.9	5.6	27.8	3.9	30.7	3.2
63	37.0	4.0	41.4	3.2	43.5	2.9	63	24.6	5.3	29.4	3.8	32.0	3.2
60	40.3	3.8	44.5	3.1	46.3	2.8	60	27.1	5.0	31.6	3.6	34.0	3.1
58	42.3	3.6	46.4	3.1	48.1	2.8	58	28.7	4.8	33.0	3.6	35.3	3.1
55	45.3	3.3	49.3	3.0	50.6	2.8	55	30.9	4.6	35.0	3.4	37.1	3.1
53	47.1	3.2	51.0	2.9	52.1	2.8	53	32.4	4.4	36.5	3.4	38.1	3.0
50	49.8	2.9	53.2	2.6	54.0	2.5	50	34.5	4.2	38.3	3.3	39.7	3.0
48	51.4	2.7	54.7	2.5	55.2	2.4	48	35.9	4.1	39.6	3.3	40.7	3.0
45	53.7	2.4	56.6	2.2	57.0	2.2	45	37.7	3.9	41.1	3.2	42.0	3.0
43	55.3	2.3	57.9	2.1			43	39.0	3.8	42.2	3.2		
40	57.2	2.0	59.6	1.8			40	40.7	3.7	43.7	3.1		
38	58.6	1.8	60.7	1.6			38	41.8	3.6	44.5	3.1		
35	60.5	1.6	62.2	1.4			35	43.3	3.5	45.8	3.1		
33	61.7	1.4	63.1	1.2			33	44.3	3.4	46.5	3.1		
30	63.3	1.2	64.3	1.0			30	45.7	3.3	47.5	3.1		
28	64.3	1.1	65.0	0.9			28	46.5	3.3	48.1	3.1		
25	65.6	0.9	65.8	0.8			25	47.6	3.2	48.8	3.1		
23	66.3	0.8					23	48.3	3.2				
20							20	49.1	3.1				
G				1			G				1		

C: Loaded boom angle (°)
 R: Load radius (m)
 W: Rated lifting capacity (Unit: x 1,000 kg)
 G: Number of parts of line

GR-1600XL RATED LIFTING CAPACITIES (IN METRIC TON)

Jib

COUNTERWEIGHT 29.3 t (64,600 lbs)							COUNTERWEIGHT 29.3 t (64,600 lbs)						
ON OUTRIGGERS FULLY EXTENDED 8.2 m (26'10-7/8") SPREAD							ON OUTRIGGERS FULLY EXTENDED 8.2 m (26'10-7/8") SPREAD						
360° ROTATION							360° ROTATION						
							Insert jib: Option						
C	61.0-m (200.1') Boom + 7.0-m (23.0') Insert jib + 18.0-m (59.1') Manual offset jib						C	57.0-m (187.0') Boom + 7.0-m (23.0') Insert jib + 18.0-m (59.1') Manual offset jib					
	0° Tilt		20° Tilt		40° Tilt			0° Tilt		20° Tilt		40° Tilt	
	R	W	R	W	R	W		R	W	R	W	R	W
81.5	17.6	3.1	24.3	2.9	29.1	2.6	81.5	15.7	3.4	22.3	3.2	27.0	2.7
81	18.6	3.1	25.3	2.9	30.0	2.6	81	16.8	3.4	23.2	3.2	27.9	2.7
80	20.6	3.1	27.4	2.9	31.9	2.6	80	18.6	3.4	25.1	3.2	29.5	2.7
79	22.6	3.1	29.3	2.9	33.6	2.6	79	20.3	3.4	26.9	3.2	31.2	2.7
78	24.6	3.1	30.9	2.8	35.1	2.5	78	22.2	3.4	28.7	3.2	32.7	2.7
77	26.6	3.1	32.6	2.7	36.7	2.5	77	24.0	3.4	30.2	3.1	34.0	2.6
76	28.4	3.1	34.1	2.6	38.2	2.4	76	25.9	3.4	31.7	3.0	35.6	2.6
75	30.1	3.0	35.6	2.5	39.5	2.3	75	27.4	3.4	33.1	2.9	36.8	2.5
73	33.3	2.8	38.7	2.4	42.2	2.2	73	30.6	3.2	35.9	2.7	39.7	2.5
70	38.0	2.5	43.1	2.2	46.0	2.0	70	34.9	2.9	40.2	2.6	43.6	2.4
68	41.2	2.4	45.9	2.1	48.5	1.9	68	38.1	2.9	42.7	2.4	46.0	2.3
65	45.5	2.2	49.7	1.9	52.1	1.8	65	42.0	2.6	46.6	2.3	49.3	2.2
63	48.2	2.1	52.2	1.8	54.4	1.7	63	44.6	2.5	49.1	2.2	51.5	2.1
60	52.0	1.9	56.0	1.7	57.7	1.6	60	48.3	2.3	52.7	2.1	54.7	2.0
58	54.4	1.8	58.4	1.7	59.9	1.6	58	50.8	2.2	54.9	2.0	56.6	1.9
55	57.9	1.6	61.3	1.4	62.6	1.4	55	54.4	2.1	58.0	1.9	59.3	1.8
53	59.9	1.4	63.3	1.3	64.1	1.2	53	56.2	1.9	59.9	1.8	60.9	1.7
50	62.8	1.2	65.7	1.0	66.6	1.0	50	59.2	1.7	62.2	1.5	63.1	1.5
48	64.6	1.0	67.2	0.8	68.0	0.8	48	61.0	1.5	63.7	1.3	64.2	1.2
45							45	63.3	1.3	65.7	1.0	66.4	1.0
43							43	65.0	1.1	67.4	0.9		
40							40	67.1	0.8				
38							38						
35							35						
33							33						
30							30						
28							28						
25							25						
23							23						
G				1			G				1		

COUNTERWEIGHT 29.3 t (64,600 lbs)							COUNTERWEIGHT 29.3 t (64,600 lbs)						
ON OUTRIGGERS FULLY EXTENDED 8.2 m (26'10-7/8") SPREAD							ON OUTRIGGERS FULLY EXTENDED 8.2 m (26'10-7/8") SPREAD						
360° ROTATION							360° ROTATION						
							Insert jib: Option						
C	52.6-m (172.5') Boom + 7.0-m (23.0') Insert jib + 18.0-m (59.1') Manual offset jib						C	35.0-m (114.9') Boom + 7.0-m (23.0') Insert jib + 18.0-m (59.1') Manual offset jib					
	0° Tilt		20° Tilt		40° Tilt			0° Tilt		20° Tilt		40° Tilt	
	R	W	R	W	R	W		R	W	R	W	R	W
81.5	14.1	3.9	20.8	3.6	25.1	2.8	81.5	8.6	5.4	14.7	4.5	19.4	3.3
81	15.0	3.9	21.6	3.6	25.8	2.8	81	9.1	5.4	15.3	4.5	19.9	3.3
80	16.7	3.9	23.4	3.6	27.4	2.8	80	10.3	5.4	16.5	4.5	21.0	3.3
79	18.4	3.9	24.8	3.5	28.9	2.8	79	11.4	5.4	17.6	4.4	22.2	3.3
78	20.1	3.9	26.3	3.4	30.3	2.8	78	12.6	5.4	18.8	4.3	22.9	3.2
77	21.7	3.9	27.8	3.3	31.6	2.7	77	13.7	5.4	19.6	4.1	23.8	3.1
76	23.3	3.9	29.2	3.2	32.9	2.7	76	14.9	5.4	20.6	4.0	25.0	3.1
75	24.9	3.9	30.6	3.1	34.1	2.6	75	16.0	5.4	21.8	3.9	25.7	3.0
73	28.2	3.9	33.3	3.0	36.6	2.5	73	18.3	5.4	23.6	3.6	27.6	2.9
70	32.3	3.6	37.3	2.8	40.2	2.4	70	21.3	4.9	26.7	3.4	30.0	2.7
68	35.1	3.5	39.8	2.7	42.6	2.4	68	23.3	4.6	28.4	3.2	31.7	2.6
65	39.0	3.2	43.6	2.6	45.9	2.3	65	26.1	4.1	31.1	3.0	34.0	2.5
63	41.5	3.1	45.9	2.5	47.9	2.2	63	28.0	3.9	33.0	2.9	35.6	2.4
60	45.1	2.9	49.2	2.4	51.0	2.2	60	30.7	3.5	35.3	2.7	37.9	2.3
58	47.2	2.7	51.3	2.3	52.8	2.1	58	32.4	3.3	36.9	2.6	39.5	2.3
55	50.5	2.5	54.2	2.2	55.7	2.1	55	35.1	3.1	39.4	2.5	41.3	2.2
53	52.5	2.4	56.1	2.1	57.1	2.0	53	36.7	3.0	40.7	2.4	42.8	2.2
50	55.2	2.1	58.6	1.9	59.5	1.9	50	39.1	2.8	42.9	2.3	44.4	2.1
48	56.9	1.9	60.2	1.8	60.8	1.7	48	40.7	2.7	44.2	2.2	45.6	2.1
45	59.3	1.7	62.2	1.5	62.6	1.4	45	42.8	2.5	46.4	2.2	47.0	2.0
43	60.8	1.5	63.4	1.3			43	44.2	2.5	47.3	2.1		
40	62.8	1.2	65.2	1.0			40	46.1	2.3	49.2	2.1		
38	64.2	1.1	66.4	0.9			38	47.4	2.3	50.0	2.0		
35	66.2	0.8					35	49.1	2.2	51.6	2.0		
33							33	50.1	2.1	52.5	2.0		
30							30	51.6	2.1	53.4	1.9		
28							28	52.5	2.0	54.0	1.9		
25							25	53.7	2.0	54.9	1.9		
23							23	54.4	2.0				
G				1			G				1		

C: Loaded boom angle (°)
 R: Load radius (m)
 W: Rated lifting capacity (Unit: x 1,000 kg)
 G: Number of parts of line

GR-1600XL RATED LIFTING CAPACITIES (IN METRIC TON)

Jib

COUNTERWEIGHT 29.3 t (64,600 lbs)							COUNTERWEIGHT 29.3 t (64,600 lbs)						
ON OUTRIGGERS FULLY EXTENDED 8.2 m (26'10-7/8") SPREAD							ON OUTRIGGERS FULLY EXTENDED 8.2 m (26'10-7/8") SPREAD						
360° ROTATION							360° ROTATION						
C	61.0-m (200.1') Boom + 14.0-m (45.9') Insert jib + 18.0-m (59.1') Manual offset jib						C	57.0-m (187.0') Boom + 14.0-m (45.9') Insert jib + 18.0-m (59.1') Manual offset jib					
	0° Tilt		20° Tilt		40° Tilt			0° Tilt		20° Tilt		40° Tilt	
	R	W	R	W	R	W		R	W	R	W	R	W
81.5	19.8	2.1	26.4	2.1	32.1	2.1	81.5	18.2	2.8	24.5	2.4	29.6	2.2
81	21.0	2.1	27.5	2.1	33.1	2.1	81	19.3	2.8	25.5	2.4	30.6	2.2
80	23.2	2.1	29.8	2.1	35.2	2.1	80	21.3	2.8	27.6	2.4	32.6	2.2
79	25.4	2.1	31.8	2.1	36.8	2.0	79	23.4	2.8	29.5	2.4	34.2	2.2
78	27.5	2.1	33.8	2.1	38.7	2.0	78	25.5	2.8	31.1	2.3	35.8	2.1
77	29.5	2.1	35.6	2.0	40.2	1.9	77	27.2	2.7	33.0	2.3	37.2	2.0
76	31.7	2.1	37.6	2.0	41.7	1.8	76	29.0	2.6	34.6	2.2	38.8	2.0
75	33.6	2.1	39.2	1.9	43.4	1.8	75	30.7	2.5	36.1	2.1	40.2	1.9
73	37.4	2.0	42.7	1.8	46.2	1.6	73	34.1	2.3	39.4	2.0	43.3	1.9
70	42.6	1.8	47.3	1.6	50.5	1.5	70	39.0	2.1	44.0	1.9	47.2	1.7
68	45.9	1.7	50.4	1.5	53.4	1.4	68	42.2	2.0	47.1	1.8	50.2	1.7
65	50.6	1.5	54.7	1.3	57.3	1.3	65	46.6	1.8	51.1	1.6	54.0	1.6
63	53.5	1.4	57.6	1.3	59.8	1.2	63	49.7	1.8	53.9	1.6	56.4	1.5
60	58.0	1.3	61.6	1.2	63.3	1.1	60	53.6	1.6	57.7	1.5	59.8	1.4
58	60.7	1.2	64.0	1.1	65.5	1.0	58	56.2	1.5	60.0	1.4	61.9	1.4
55	64.0	0.9	67.0	0.8	68.6	0.8	55	60.0	1.4	63.4	1.3	64.7	1.2
53							53	62.1	1.2	65.2	1.1	66.4	1.1
50							50	65.3	1.0	68.1	0.9	69.0	0.9
48							48	67.3	0.8	69.8	0.8	70.5	0.8
45							45						
43							43						
40							40						
38							38						
35							35						
33							33						
30							30						
28							28						
25							25						
23							23						
G			1				G			1			

COUNTERWEIGHT 64,600 lbs (29.3 t)							COUNTERWEIGHT 64,600 lbs (29.3 t)						
ON OUTRIGGERS FULLY EXTENDED 26'10-7/8" (8.20 m) SPREAD							ON OUTRIGGERS FULLY EXTENDED 26'10-7/8" (8.20 m) SPREAD						
360° ROTATION							360° ROTATION						
C	52.6-m (172.5') Boom + 14.0-m (45.9') Insert jib + 18.0-m (59.1') Manual offset jib						C	35.0-m (114.9') Boom + 14.0-m (45.9') Insert jib + 18.0-m (59.1') Manual offset jib					
	0° Tilt		20° Tilt		40° Tilt			0° Tilt		20° Tilt		40° Tilt	
	R	W	R	W	R	W		R	W	R	W	R	W
81.5	16.4	3.2	22.4	2.7	27.5	2.4	81.5	10.4	4.4	16.4	3.6	21.2	2.9
81	17.4	3.2	23.4	2.7	28.2	2.4	81	11.1	4.4	17.1	3.6	21.9	2.9
80	19.4	3.2	25.3	2.7	30.1	2.4	80	12.5	4.4	18.4	3.6	23.0	2.9
79	21.3	3.2	27.1	2.7	31.7	2.4	79	13.8	4.4	19.6	3.5	24.1	2.8
78	23.1	3.2	28.6	2.6	33.1	2.3	78	15.1	4.4	20.8	3.4	25.4	2.8
77	24.9	3.1	30.1	2.5	34.5	2.2	77	16.4	4.4	22.0	3.3	26.3	2.7
76	26.5	3.0	31.7	2.4	36.1	2.2	76	17.6	4.3	23.2	3.2	27.4	2.6
75	28.1	2.9	33.4	2.4	37.3	2.1	75	18.9	4.1	24.4	3.1	28.3	2.5
73	31.3	2.7	36.1	2.2	40.2	2.0	73	21.1	3.8	26.4	2.9	30.4	2.4
70	36.0	2.5	40.6	2.1	44.1	1.9	70	24.6	3.4	29.8	2.7	33.3	2.2
68	38.9	2.3	43.4	2.0	46.6	1.8	68	26.8	3.2	31.9	2.5	35.2	2.1
65	43.3	2.2	47.2	1.8	50.2	1.7	65	30.1	2.9	34.9	2.3	37.7	1.9
63	45.8	2.0	49.7	1.7	52.5	1.6	63	32.3	2.8	36.7	2.1	39.5	1.8
60	49.8	1.9	53.4	1.6	55.9	1.5	60	35.2	2.5	39.5	2.0	42.0	1.7
58	52.3	1.8	55.9	1.6	58.0	1.5	58	37.3	2.4	41.4	1.9	43.6	1.6
55	56.0	1.7	59.2	1.5	60.9	1.4	55	40.0	2.1	43.9	1.7	45.9	1.5
53	58.1	1.6	61.4	1.5	62.8	1.4	53	41.8	2.0	45.6	1.6	47.5	1.5
50	61.0	1.3	64.1	1.3	65.1	1.2	50	44.5	1.9	48.0	1.5	49.4	1.4
48	63.0	1.2	65.7	1.1	66.5	1.1	48	46.2	1.8	49.7	1.5	50.9	1.4
45	65.6	1.0	68.1	1.0	68.6	0.9	45	48.5	1.6	51.8	1.4	52.5	1.3
43	67.1	0.9	69.5	0.9			43	50.2	1.6	53.2	1.4		
40							40	52.2	1.5	55.1	1.3		
38							38	53.6	1.4	56.2	1.3		
35							35	55.4	1.3	57.6	1.2		
33							33	56.6	1.3	58.7	1.2		
30							30	58.2	1.2	59.8	1.1		
28							28	59.1	1.2	60.5	1.1		
25							25	60.4	1.1	61.7	1.1		
23							23	61.2	1.1				
G			1				G			1			

C: Loaded boom angle (°)
 R: Load radius (m)
 W: Rated lifting capacity (Unit: x 1,000 kg)
 G: Number of parts of line

GR-1600XL RATED LIFTING CAPACITIES (IN METRIC TON)

Jib

COUNTERWEIGHT 29.3 t (64,600 lbs)					COUNTERWEIGHT 29.3 t (64,600 lbs)				
ON OUTRIGGERS FULLY EXTENDED 8.2 m (26'10-7/8") SPREAD					ON OUTRIGGERS FULLY EXTENDED 8.2 m (26'10-7/8") SPREAD				
360° ROTATION					360° ROTATION				
					Short jib: Option				
C	61.0-m (200.1') Boom + 3.6-m (11.8') Short jib		40° Tilt		C	57.0-m (187.0') Boom + 3.6-m (11.8') Short jib		40° Tilt	
	20° Tilt		R	W		20° Tilt		R	W
	R	W				R	W		
81.5	14.1	9.4	15.6	9.2	81.5	12.7	10.8	13.6	10.5
81	14.8	9.2	16.2	9.1	81	13.3	10.7	14.2	10.3
80	16.1	9.0	17.5	8.8	80	14.5	10.3	15.4	10.0
79	17.4	8.7	18.7	8.5	79	15.5	10.0	16.4	9.6
78	18.5	8.4	19.8	8.2	78	16.6	9.6	17.6	9.3
77	19.7	8.1	20.9	7.9	77	17.8	9.3	18.6	9.0
76	20.9	7.8	22.1	7.7	76	18.8	9.0	19.6	8.7
75	22.0	7.5	23.2	7.4	75	19.9	8.7	20.7	8.4
73	24.3	7.0	25.3	6.9	73	22.0	8.1	22.7	7.9
70	27.4	6.3	28.5	6.2	70	25.0	7.4	25.7	7.3
68	29.5	5.9	30.4	5.8	68	26.9	6.9	27.6	6.8
65	32.5	5.3	33.4	5.3	65	29.8	6.3	30.3	6.2
63	34.4	5.0	35.2	4.9	63	31.6	6.0	32.2	5.9
60	37.2	4.5	37.9	4.5	60	34.2	5.4	34.6	5.4
58	39.0	4.3	39.5	4.2	58	35.9	5.1	36.3	5.1
55	41.6	3.9	42.1	3.9	55	38.3	4.7	38.6	4.7
53	43.2	3.7	43.5	3.5	53	39.9	4.5	40.1	4.5
50	45.3	3.1	45.5	2.9	50	42.0	4.0	42.1	3.9
48	46.7	2.7	46.8	2.6	48	43.3	3.6	43.4	3.5
45	48.7	2.3	48.8	2.2	45	45.2	3.1	45.2	3.0
43	49.9	2.0	50.0	1.9	43	46.4	2.8	46.4	2.7
40	51.7	1.7	51.8	1.6	40	48.1	2.4	48.1	2.3
38	52.8	1.5			38	49.2	2.2		
35	54.3	1.2			35	50.6	1.9		
33	55.2	1.0			33	51.6	1.7		
30	56.6	0.8			30	52.8	1.5		
28					28	53.6	1.4		
25					25	54.6	1.2		
20					20	56.0	1.0		
G			2		G			2	

COUNTERWEIGHT 29.3 t (64,600 lbs)					COUNTERWEIGHT 29.3 t (64,600 lbs)				
ON OUTRIGGERS FULLY EXTENDED 8.2 m (26'10-7/8") SPREAD					ON OUTRIGGERS FULLY EXTENDED 8.2 m (26'10-7/8") SPREAD				
360° ROTATION					360° ROTATION				
					Short jib: Option				
C	52.6-m (172.5') Boom + 3.6-m (11.8') Short jib		40° Tilt		C	35.0-m (114.9') Boom + 3.6-m (11.8') Short jib		40° Tilt	
	20° Tilt		R	W		20° Tilt		R	W
	R	W				R	W		
81.5	11.2	13.1	12.1	12.6	81.5	6.5	22.2	6.9	18.0
81	11.8	12.9	12.7	12.4	81	6.8	22.0	7.2	17.9
80	12.9	12.4	13.8	11.9	80	7.5	21.7	7.9	17.7
79	13.9	12.0	14.8	11.5	79	8.2	21.3	8.6	17.5
78	15.0	11.6	15.8	11.1	78	8.9	21.0	9.2	17.4
77	16.0	11.2	16.8	10.8	77	9.5	20.7	9.9	17.2
76	17.0	10.7	17.8	10.4	76	10.2	20.4	10.5	17.1
75	18.0	10.3	18.7	10.0	75	10.8	20.1	11.2	16.9
73	19.9	9.6	20.6	9.3	73	12.1	19.6	12.5	16.7
70	22.7	8.6	23.3	8.4	70	14.0	18.9	14.3	16.3
68	24.4	8.0	24.8	7.9	68	15.3	18.5	15.6	16.2
65	27.0	7.3	27.6	7.2	65	17.1	18.0	17.4	15.9
63	28.7	6.9	29.2	6.8	63	18.3	17.7	18.6	15.8
60	31.1	6.3	31.6	6.3	60	19.9	16.9	20.2	15.6
58	32.7	6.0	33.1	5.9	58	21.0	16.3	21.3	15.5
55	35.0	5.6	35.3	5.5	55	22.5	15.2	22.9	14.9
53	36.5	5.3	36.7	5.2	53	23.5	14.1	23.8	13.8
50	38.4	4.7	38.6	4.6	50	24.9	12.6	25.1	12.5
48	39.7	4.3	39.8	4.2	48	25.8	11.8	26.0	11.7
45	41.5	3.8	41.5	3.6	45	27.1	10.8	27.2	10.7
43	42.6	3.4	42.6	3.3	43	27.9	10.2	28.0	10.1
40	44.2	3.0	44.2	2.9	40	29.0	9.4	29.2	9.3
38	45.2	2.7			38	29.8	8.9		
35	46.6	2.4			35	30.8	8.3		
33	47.5	2.2			33	31.4	8.0		
30	48.7	1.9			30	32.3	7.6		
28	49.4	1.8			28	32.9	7.3		
25	50.4	1.6			25	33.6	7.0		
20	51.7	1.4			20	34.6	6.5		
G			2		G			4	

C: Loaded boom angle (°)
 R: Load radius (m)
 W: Rated lifting capacity (Unit: x 1,000 kg)
 G: Number of parts of line

GR-1600XL RATED LIFTING CAPACITIES (IN METRIC TON)

WITHOUT COUNTERWEIGHT ON-RUBBER STATIONARY												
A	Over front and rear						360° Rotation					
	13.1 m		17.4 m		21.8 m		13.1 m		17.4 m		21.8 m	
	C	(42.8')	C	(57.2')	C	(71.6')	C	(42.8')	C	(57.2')	C	(71.6')
2.50	73	10.0	78	10.0	80	10.0	73	10.0	78	10.0	80	10.0
3.00	71	10.0	76	10.0	79	10.0	71	10.0	76	10.0	79	10.0
3.50	68	10.0	74	10.0	78	10.0	68	9.9	74	10.0	78	10.0
4.00	66	10.0	72	10.0	76	10.0	66	8.0	72	9.7	76	10.0
4.50	63	10.0	71	10.0	75	10.0	63	6.4	71	8.1	75	9.0
5.00	61	9.2	69	10.0	74	10.0	61	5.1	69	6.8	74	7.7
5.50	58	8.0	67	9.5	72	10.0	58	4.0	67	5.7	72	6.6
6.00	55	6.9	65	8.4	71	9.1	55	3.0	65	4.7	71	5.6
6.50	52	5.9	63	7.4	69	8.1	52	2.1	63	3.9	69	4.8
7.00	49	5.1	61	6.5	68	7.4			61	3.1	68	4.1
7.50	46	4.3	59	5.8	67	6.6			59	2.4	67	3.3
8.00	43	3.3	57	5.1	65	5.9			57	1.7	65	2.7
9.00	35	1.8	53	3.7	62	4.6					62	1.7
10.00			49	2.4	59	3.4						
11.00			44	1.5	56	2.4						
12.00					52	1.7						
D	0		40		50		47		56		59	
Telescoping conditions (%)												
Tele. 1	0		0		0		0		0		0	
Tele. 2	0		0		0		0		0		0	
Tele. 3	0		0		0		0		0		0	
Tele. 4	0		0		0		0		0		0	
Tele. 5	0		45		90		0		45		90	
E	4		4		4		4		4		4	

A: Boom length (m)
 B: Load radius (m)
 C: Loaded boom angle (°)
 D: Minimum boom angle (°)
 for indicated length (no load)
 E: Number of parts of line

NOTE: The lifting capacity data stowed in the LOAD MOMENT INDICATOR (AML-C) is based on the standard number of parts of line listed in the chart. Standard number of parts of line for on-rubber operation should be according to the chart.

WARNING AND OPERATING INSTRUCTIONS FOR ON RUBBER LIFTING CAPACITIES

- Rated lifting capacities on-rubber do not exceed 75% of tipping loads as determined by SAE J765-Crane Stability Test Code.
- On rubber lifting is only permitted without counterweight and stationary. Creep operation is prohibited. Rated lifting capacities shown in the chart are based on the condition that crane is set on firm level surfaces with suspension lock applied. Those above thick lines are based on tire capacity and those below, on crane stability. They are based on actual load radius increased by tire deformation and boom deflection.
- If the suspension lock cylinders contain air, the axle will not be locked completely and rated lifting capacities may not be obtainable. Bleed the cylinders according to the operation safety and maintenance manual.
- Rated lifting capacities are based on proper tire inflation, capacity and condition. Damaged tires are hazardous to safe operation of crane.
- Tires shall be inflated to correct air pressure.
- On rubber lifting with "jib" is not permitted. Maximum permissible boom length is 21.8 m (71.6').
- When making lift on rubber stationary, set parking brake.
- The mass of the hook (1,080 kg (2,381 lbs) for 100 metric ton (110 ton) capacity, 300 kg (661 lbs) for 7.2 metric ton (7.9 ton) capacity), slings and all similarly used load handling devices must be considered as part of the load and must be deducted from the lifting capacities.
- For rated lifting capacity of single top, reduce the rated lifting capacities of relevant boom according to a weight reductions for auxiliary load handling equipment. Capacities of single top shall not exceed 7,200 kg (15,900 lbs) including main hook.
- The lifting capacity data stowed in the LOAD MOMENT INDICATOR (AML-C) is based on the standard number of parts of line listed in the chart. Standard number of parts of line for on rubber operation should be according to the following table.

Boom length	Number of parts of line
13.1 m (42.8') to 21.8 m (71.6')	4

Tires	Air Pressure
26.5R25☆☆☆	650 kPa (94 psi)

- Over front operation shall be performed within 10 degrees in front of chassis.

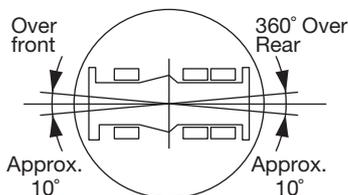

WARNING AND OPERATING INSTRUCTIONS FOR LIFTING CAPACITIES

GENERAL

1. RATED LIFTING CAPACITIES apply only to the machine as originally manufactured and normally equipped by TADANO LTD. Modifications to the machine or use of optional equipment other than that specified can result in a reduction of capacity.
2. Hydraulic cranes can be hazardous if improperly operated or maintained. Operation and maintenance of this machine must be in compliance with information in the Operation and Maintenance Manual supplied with the crane. If this manual is missing, order a replacement through the distributor.
The operator and other personnel associated with this machine shall fully acquaint themselves with the latest applicable ASME B30.5 safety standards for cranes as mentioned in OSHA CFR29 part 1926.

SET UP

1. Rated lifting capacities on the load chart are the maximum allowable crane capacities, are based on the machine standing level on firm supporting surface under ideal job conditions. Depending on the nature of the supporting surface, it may be necessary to have structural supports under the outrigger floats or tires to spread the loads to a larger surface.
2. For outrigger operation, outriggers shall be properly extended with tires free of supporting surface before operating crane.

OPERATION

1. Rated lifting capacities have been tested to and meet minimum requirements of SAE J1063-Cantilevered Boom Crane Structures Method of Test.
2. Rated lifting capacities do not exceed 85% of the tipping load on outriggers fully extended as determined by SAE J765-Crane Stability Test Code.
Rated lifting capacities for partially extended outriggers are determined from the formula, $\text{Rated Lifting Capacities} = (\text{Tipping Load} - 0.1 \times \text{Tip Reaction}) / 1.25$.
3. Rated lifting capacities above thick lines in the chart are based on crane strength and those below, on its stability. They are based on actual load radius increased by boom deflection.
4. The weight of handling device such as hook blocks, slings, etc., must be considered as part of the load and must be deducted from the lifting capacities.
5. Rated lifting capacities are based on freely suspended loads and make no allowance for such factors as the effect of wind, sudden stopping of loads, supporting surface conditions, inflation of tires, operating speeds, side loads, etc. Side pull on the boom or jib is extremely dangerous.
Such action can damage the boom, jib or slewing mechanism, and lead to overturning the crane.
6. Rated lifting capacities do not account for wind on lifted load or boom. We recommend against working under the conditions that the load is out of control due to a strong wind. During boom lift, consider that the rated lifting capacity is reduced by 50% when the wind speed is 9 m/s (20 mph) to 12 m/s (27 mph); reduced by 70% when the wind speed is 12 m/s (27 mph) to 14 m/s (31 mph). If the wind speed is 14 m/s (31 mph) or over, stop operation. During jib lift, stop operation if the wind speed is 9 m/s (20 mph) or over.

7. Rated lifting capacities at load radius shall not be exceeded. Do not tip the crane to determine allowable loads.
8. Do not operate at boom lengths, radii, or boom angle, where no capacities are shown. Crane may overturn without any load on the hook.
9. When boom length is between values listed, refer to the rated lifting capacities of the next longer and next shorter booms for the same radius. The lesser of the two rated lifting capacities shall be used.
10. When making lifts at a load radius not shown, use the next longer radius to determine allowable capacity.
11. Load per line should not exceed 7,200 kg (15,900 lbs) for main winch and auxiliary winch.
12. Check the actual number of parts of line with LOAD MOMENT INDICATOR (AML-C) before operation. Maximum lifting capacity is restricted by the number of parts of line of LOAD MOMENT INDICATOR (AML-C). Limited capacity is as determined from the formula, $\text{Single line pull for main winch } 7,200 \text{ kg (15,900 lbs)} \times \text{number of parts of line}$.
13. The boom angle before loading should be greater to account for deflection. For rated lifting capacities, the loaded boom angle and the load radius is for reference only.
14. Do not operate extension or retraction of the boom with loads.
15. For lifting capacity of single top, deduct the weight of the load handling equipment from the rated lifting capacity of the boom. For the lifting capacity of single top, the net capacity shall not exceed 7,200 kg (15,900 lbs) including main boom hook mass attached to the boom.
16. When the base jib or top jib or both jibs are removed, set the jib state switch to the REMOVED position.
17. When erecting and stowing jib, be sure to retain it by hand or by other means to prevent its free movement.
18. Use "ANTI-TWO-BLOCK DEVICE" disable switch when erecting and stowing jib and when stowing hook block. While the switch is pushed, the winch does not stop, even when overwind condition occurs.
19. For selected boom length or less with jib, rated lifting capacities are determined by loaded boom angle only in the column headed "selected boom + jib".
20. Outriggers shall be extended 8.2 m (26' 10-7/8") spread when installing or removing removable counterweight.

DEFINITIONS

1. Load Radius: Horizontal distance from a projection of the axis of rotation to supporting surface before loading to the center of the vertical winch line or tackle with load applied.
2. Loaded Boom Angle: The angle between the boom base section and the horizontal, after lifting the rated lifting capacity at the load radius.
3. Working Area: Area measured in a circular arc about the centerline of rotation.
4. Freely Suspended Load: Load hanging free with no direct external force applied except by the winch line.
5. Side Load: Horizontal side force applied to the lifted load either on the ground or in the air.

WARNING AND OPERATING INSTRUCTIONS FOR USING THE LOAD MOMENT INDICATOR (AML-C)

- Set AML select keys in accordance with the actually operating crane conditions and don't fail to make sure, before crane operation, that the displays on front panel are correct.
- When operating crane on outriggers:
 - Set P.T.O. switch to "ON".
 - Press the outrigger state select key to register for the outrigger operation. If the display agrees with the actual state, press the set key to register. After the completion of the registration, the pop-up window closes.
 - Press the lift state select key to register the lift state to be used (single top / jib / boom).
 - Each time the lift state select key is pressed, the display changes. If the display agrees with the actual state, press the set key to register. After the completion of the registration, the pop-up window closes.
 - When erecting and stowing jib, select the status of jib set (Jib lift indicator symbol flickers).
- When operating crane on rubber:
 - Set P.T.O. switch to "ON".
 - Press the outrigger state select key to register for the on rubber operation. Each time the outrigger state select key is pressed, the display changes. Select the stationary operation, the on rubber state indicative symbol flickers.
 - Press the lift state select key to register the lift state.

However, pay attention to the following.
For stationary operation.

 - The front and rear capacities are attainable only when the over front or rear position. The front capacities are attainable only when the over front position symbol comes on. When the boom is more than 2 degrees from centered over front of chassis, 360° capacities are in effect.
 - When a load is lifted in the front or rear position and then swung to the side area, make sure the value of the LOAD MOMENT INDICATOR (AML-C) is below the 360° lifting capacity.
- This machine is equipped with an automatic slewing stop device. (For the details, see Operation and Maintenance Manual.) But, operate very carefully because the automatic slewing stop does not work in the following case.
 - During on-rubber operation.
 - When the "P.T.O" switch is set to "OVERRIDE" and the "OVERRIDE" key switch outside the cab is on.
- During crane operation, make sure that the displays on front panel are in accordance with actual operating conditions.
- The displayed values of LOAD MOMENT INDICATOR (AML-C) are based on freely suspended loads and make no allowance for such factors as the effect of wind, sudden stopping of loads, supporting surface conditions, inflation of tire, operating speed, side loads, etc.
For safe operation, it is recommended when extending and lowering boom or slewing, lifting loads shall be appropriately reduced.
- LOAD MOMENT INDICATOR (AML-C) is intended as an aid to the operator. Under no condition should it be relied upon to replace use of capacity charts and operating instruction. Sole reliance upon LOAD MOMENT INDICATOR (AML-C) aids in place of good operating practice can cause an accident. The operator must exercise caution to assure safety.

GR-1600XL Axle weight distribution chart

Manual offset jib	Kilograms				Pounds			
	GVW	1st	2nd	3rd	GVW	1st	2nd	3rd
Basic machine	90,805	28,701	30,814	31,290	200,191	63,275	67,933	68,983
Remove: 1. 7.2 metric ton (7.9 ton) hook block	-300	-421	61	61	-661	-928	134	134
2. 100 metric ton (110 ton) hook block	-1,080	-1,771	346	346	-2,381	-3,904	763	763
3. Counterweight 11,100 kg (24,500 lbs)	-11,120	3,351	-7,236	-7,236	-24,515	7,388	-15,953	-15,953
4. Counterweight 18,200 kg (40,100 lbs)	-18,160	5,473	-11,816	-11,816	-40,036	12,066	-26,050	-26,050
5. Front and rear outrigger boxes and beams	-8,962	-3,463	-2,750	-2,750	-19,758	-7,635	-6,063	-6,063
6. Auxiliary Winch & wire rope	-1,202	490	-846	-846	-2,650	1,080	-1,865	-1,865
7. Boom and Jib	-17,074	-21,845	2,386	2,386	-37,642	-48,160	5,260	5,260



TADANO

TADANO LTD. (International Sales Division)

4-12, Kamezawa 2-chome,
Sumida-ku, Tokyo 130-0014, Japan

Tel: +81-(0)3-3621-7750

Fax: +81-(0)3-3621-7785

<http://www.tadano.com/>

info@tadano.com

Printed in Japan
2016-05-1