

OPTIONAL EQUIPMENT

for TM-ZX1200HRS/HS

Rear Outriggers

- Outrigger beam extension type
- Outrigger beam non-extension type

Oil Cooler

The oil cooler maintains the temperature of the hydraulic oil low, keeping it safe and improving the operating efficiency of the crane.
Use the oil cooler to cool the hydraulic oil when the oil temperature rises significantly, such as when the machine is used continuously at high load.

Basket Mounting Support

Baskets that conform to the following specs may be mounted on the crane:

- Basket weight: 200 kg or less
- Basket capacity: 200 kg or less
- Basket arm length: 17,000 mm or less

Please mount the basket according to the basket's user manual.

Optional for TM-ZX1205HRS only

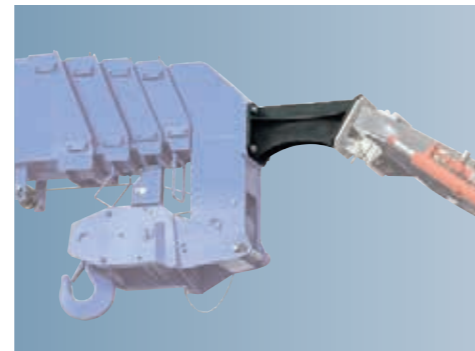

Maintenance Cock

Convenient when carrying out maintenance such as when changing hydraulic oil or parts.



Note: Some specifications are subject to change.



Tadano Ltd.
KANDA SQUARE 18th Floor,
2-2-1 Kanda-Nishikicho, Chiyoda-ku, Tokyo 101-0054, Japan
Phone: +81-3-6811-7309
www.tadano.com E-mail: info@tadano.com



TM-ZX1200HRS/HS-E-23-1-012-71-627-B1
Printed in Japan



Lifting your dreams

TRUCK LOADER CRANE

TM-ZX1200HRS/HS

For Large Size Vehicles

CARGO CRANE



Rear outriggers are optional.

TADANO QUALITY: advanced safety and power in a single package.

The TM-ZX1200HRS/HS is a more powerful crane that comes with the sophisticated, high-quality Safety Eyes System as standard equipment. Delivering greater safety and peace of mind.

TM-ZX1200HRS/HS



Safety Eyes See p. 3-4



**WATER &
DUST-RESISTANCE**
[IP66K**]

Emergency stop

Radio Controller with Color LCD* Display *Liquid-Crystal Display

A radio controller for remotely operating the crane is optionally provided, and it employs a large-screen and power-saving color LCD display, has a feature that can customize speed adjustment for various operations, and has an emergency stop switch in addition to displaying the actual load, rated load, and moment load ratio.

The "load weight" function enables to check the work progress and the load weight on the vehicle, which also prevents overloading. These features contribute to not only the safety of crane work, but also to the safety of the vehicle when it is traveling.

Note: TM-ZX1205HS model does not include radio controller.

**The IP rating indicates water proofness and dust proofness as defined in IEC 60529. An IP66K rating indicates an exceptional level of water and dust proofness, ensuring peace of mind.



AML (Automatic Moment Limiter)

The AML that monitors crane work safety is equipped as standard and it provides a "strength monitoring" function, which prevents crane overloading, and a "stability monitoring" function, which prevents the crane from falling over.

Manually entering the number of parts of line in use allows for fine-tuned controls. As the crane approaches rated performance, warning alarms and lamps are triggered. As an extra level of safety, operation is automatically stopped once critical parameters are reached.



Safety Eyes



"Safety Eyes" system consists of an "Automatic Moment Limiter", "Boom jack interlock system", and a "Working height limiter", etc., to monitors work safety. This system enables work to be performed safely.

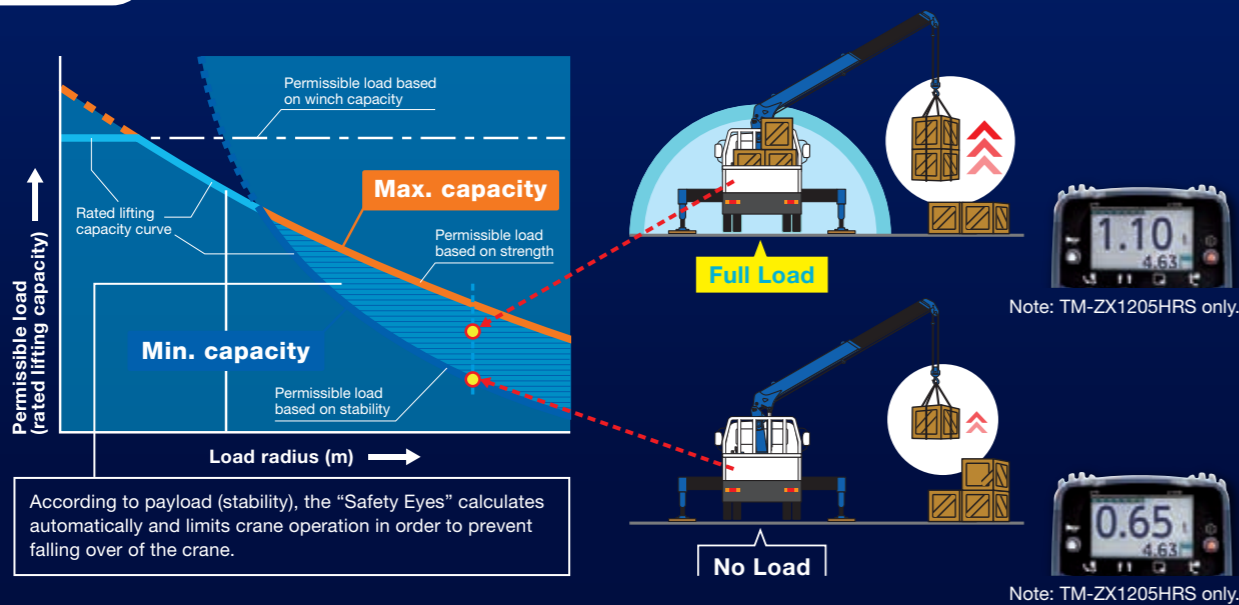

Carry Heavier Loads When Close

Carry Loads Farther When Light

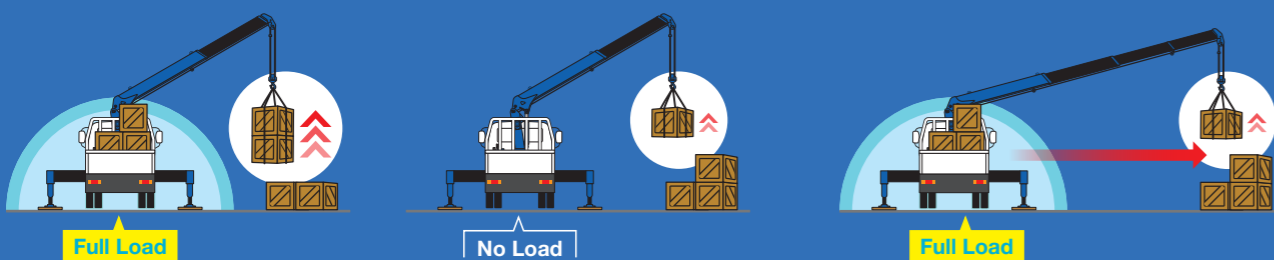

Calculations are automatic based on loaded cargo (stability), allowing you to carry heavier loads farther when fully loaded.

Feeling Operation

The operation speed of the machine when the trigger is pulled can be increased or decreased from the standard speed.

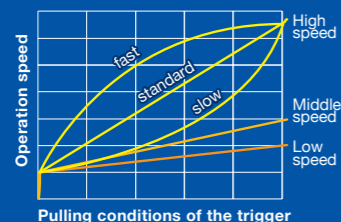

Registering the Hook Block and Number of Parts of Line

Every time the hook block/part line select switch on the conroll panel is pressed, the indications of the hook block and the number of parts of line change.

Outriggers Asymmetric Extension Width Control

Optimum Lifting Performance at Any Outrigger Width

Constantly monitors slewing angle and difference in outrigger extension widths. Crane motion is controlled according to the extension width of each outrigger.

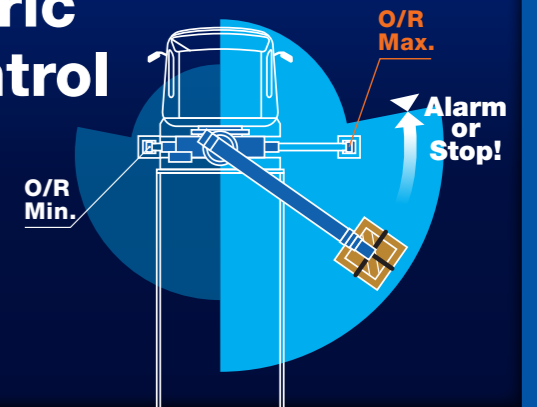

Working Height Limit Function

A function to preset the upper limit of the boom height (stop position). This is quite effective in work sites where attention is required to the boom height, such as under power lines and indoors.

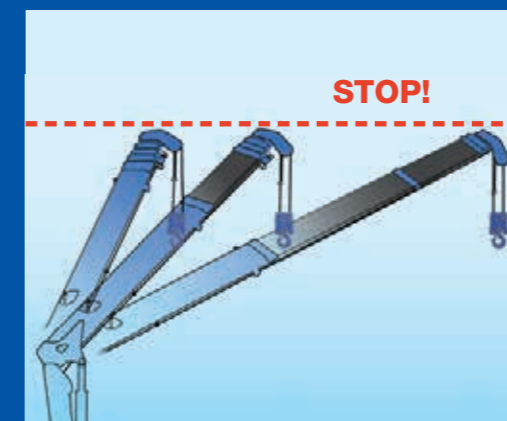

Jack Interlock

Disables crane operation when the left or right jack is not in contact with the ground.



Safety Lamp Equipped Centralized Control Panel

As operation begins to approach critical levels, safety lamps begin to flash (preliminary warning). If operation continues past this point, warning lights grow more intense once the danger level reaches 100% (limit warning).

See p. 7

Limit Warning Lamps

Warning light on the control panel, moment indicator in the radio controller and three -cooler limit warning lamp at crane post and warning alarm respectively work in tandem.

Limit warning lamp

Rated lifting capacity display

Crane strength rated lifting capacity (t) and load ratio (%) can be displayed with display switching function.

Mode display

Actual load (t) and total PTO ON time (hrs) can be displayed with display switching function.

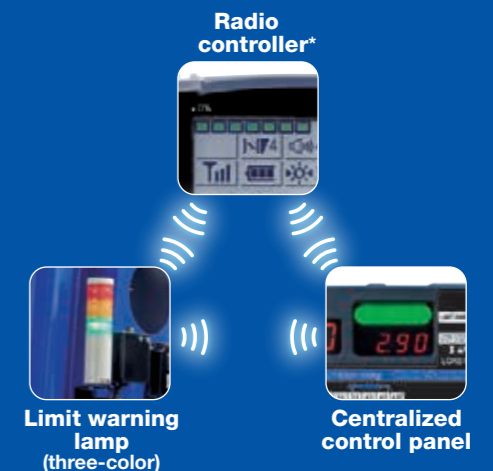

*TM-ZX1205HRS only

TM-ZX1200 HRS/HS

**Cargo Crane
for Large Size
Vehicles**

Hook-in / out System



TADANO original hook-in system is equipped as standard and enhances work efficiency. During hook-out, the boom hoists automatically to avoiding hitting cargo.

Anti-two-block Function

This function stops crane operation (hoisting up, boom elevation, and boom extension) when the hook block touches the weight, and warns the operator with an alarm, to prevent the hook block from hitting the boom head.

High-powered Radio Controller

Radio Controller with powerful transmitting output automatically selects a frequency free of jamming, out of as many frequencies as 40 channels, to avoid interference troubles.

Note: TM-ZX1205HRS only.

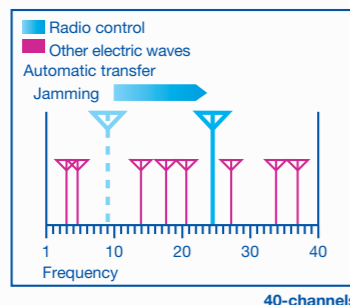

Strong Pentagonal Boom

TADANO's strong and light Pentagonal boom made of high tensile steel thoroughly designed and well proven for its quality, strength and smoothness, with a rigid and fine-tuned telescoping boom providing comfortable crane operation.

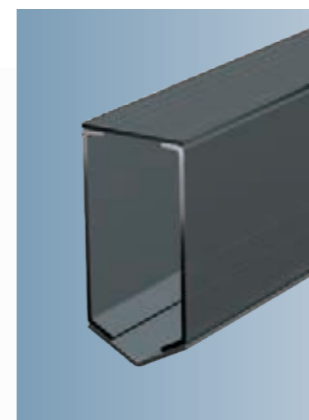

Automatic Slewing Lock System

The boom is mechanically locked securely at the boom post base to prevent the boom from accidentally slewing out during travel.

Powerful Elevating Cylinder

The cylinder use hydraulic, control, and processing technologies cultivated from more than 50 years of manufacturing experience, supporting greater work capacity.

Cable Follower

The cable follower prevents disorderly cable (wire rope) winding by always pressing the cable onto the winch drum and puts the wire rope at a right position.

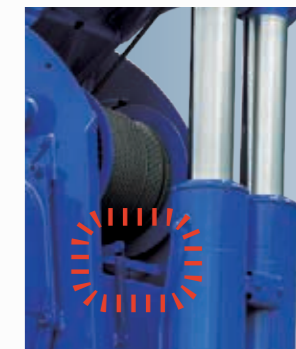

Strong and wide Outrigger

Strong 5.5 m width and powerful outriggers with box structure jacks, an easy and safe lock system together with new universal floats. The lock system is one of the advanced reliable TADANO standard safety systems.

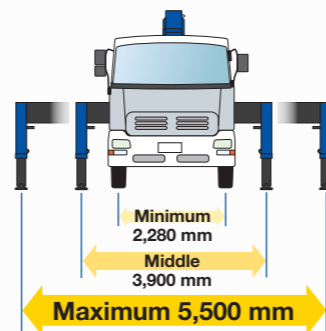

Big Hydraulic Tank

Big hydraulic tank with approximately 102 liter capacity.



Tiltable Front Outrigger Jack Float

Tiltable float rotates 360 degrees to fit any ground, for better stability. Large floats reduce ground pressure.

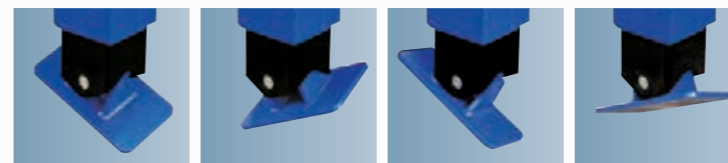
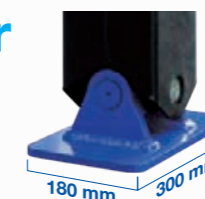

Limit Warning Lamps (Three-color) is Optional.

Centralized Control Panel

On the upper section, the digital displays for the actual load and crane strength rated lifting capacity are built in. In addition, the limit warning lamp and outrigger extension status indicator lamp are provided. The control panel also indicates the empty chassis rated lifting capacity table and the crane strength rated lifting capacity, and working range chart. Various functional switches are compactly gathered on the lower section.

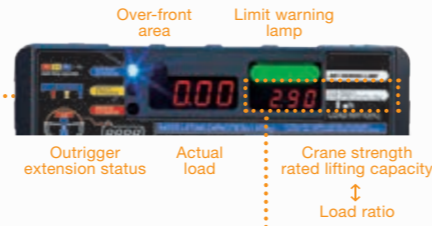

Rated lifting capacity display

Crane strength rated lifting capacity (t) and load ratio (%) can be displayed with display switching function.



Numeric keypad display

Mode display

Actual load (t) and total PTO ON time (hrs) can be displayed with display switching function.



Hour meter

Displays the crane operating hours as a guide for the maintenance timing.



Control levers and new centralized control panel (on the right side of the main body)

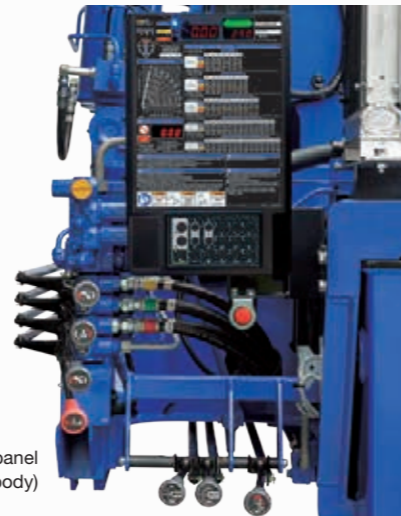

Emergency Stop

Use this switch to stop the machine movement if the machine cannot be controlled during crane operation, and in an emergency. (Outrigger operation does not stop.)



On machine



On radio controller

Note: TM-ZX1205HRS only.

Spirit Level

Used to check that the machine is set horizontally in left and right directions when the outriggers are set up.



OPTIONAL EQUIPMENT Basket Mode

Optional for TM-ZX1205HRS only

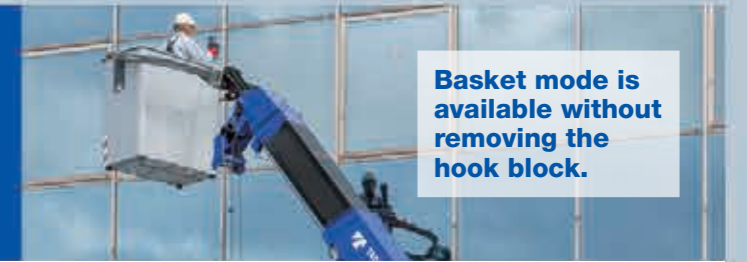

Basket mode is available without removing the hook block.

Basket Mode Working Range

Working range is calculated by strict safety measures, it make us work with safety.

Note: In order to ensure safety, the crane will automatically stop when in basket mode even with alarm specification.

Table A

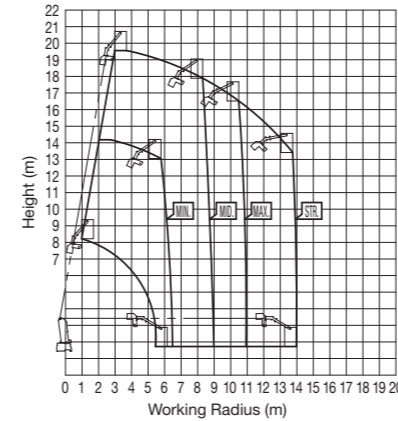

Table B

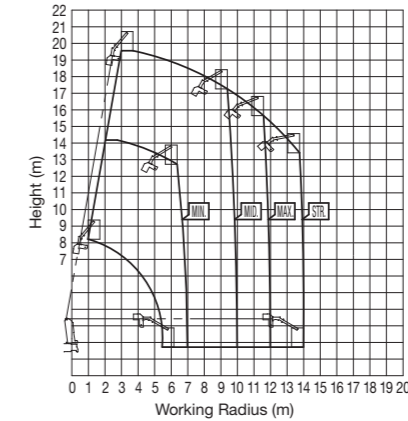
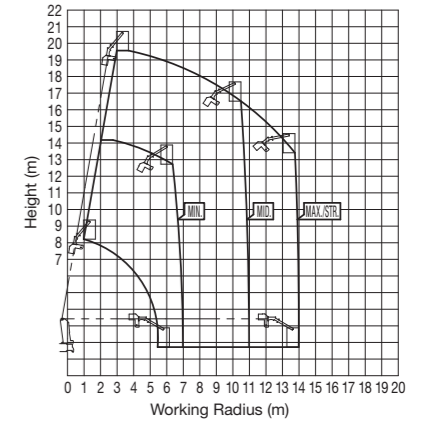

Table C



Basket Mode Working Range Notes:

1. The indicated working range assumes that the machine is set up on a firm and level ground, and does not include boom deflection.
2. This working range chart shows the over-side and over-rear areas. (The working range is up to "STR." when the stability is maximum. When the stability is minimum, the working range is in accordance with the outrigger extension width during work.)
3. The working range in the over-front area is smaller than the indication in the working range chart.
4. "MAX.", "MID.", and "MIN." indicates the outrigger extension widths.
5. This working range chart is an example, and the actual work range varies depending on the shape of the basket.

Mountable basket specifications

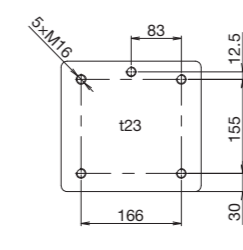
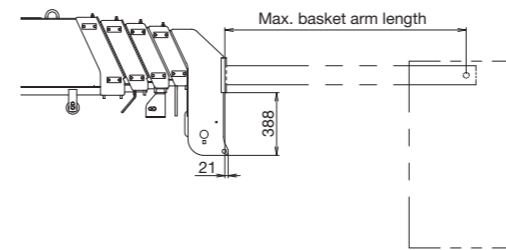

Basket mounting plate

Max. basket weight	200 kg
Max. basket loading capacity	200 kg
Max. basket arm length	1700 mm

- The size of mounting bolt is M16x2.0, and the length should be selected so that the engagement allowance is 13mm or more and 24mm less.
- Use bolts with a strength classification of 10.9 or equivalent and washers suitable for the bolts.
- Tightening torque : 147±8[N · m]

(When using optional basket mounting support)

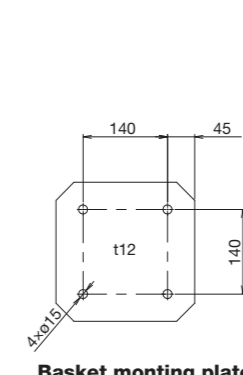
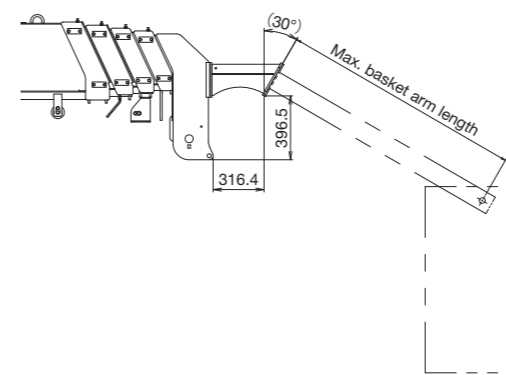

Basket mounting plate

Max. basket weight	200 kg
Max. basket loading capacity	200 kg
Max. basket arm length	1500 mm

TM-ZX1200HRS/HS

Technical Specifications

Model	TM-ZX1205HRS/HS
MAXIMUM LIFTING CAPACITY	12,000 kg at 1.6 m (8-part line)
CRANE CAPACITY	8,800 kg at 2.5 m (8-part line)
BOOM	Five-sectioned, fully powered partly synchronized telescoping boom of pentagonal box construction with 4 sheaves at boom head
Fully retracted length	4.48 m
Fully extended length	16.00 m
Extension speed	11.5 m in 38 s
Elevation	Elevated by two double-acting hydraulic cylinders
Boom raising speed	0° to 80° in 22 s
Boom point	4 sheaves
WINCH	Hydraulic motor driven. Spur gear speed reduction, provided with mechanical brake and cable follower
Single line pull	14.96 kN (1,525 kgf)
Single line speed	44 m/min (at 4th layer)
Wire rope(Diameter x length)	10 mm x 95 m
Wire rope(Breaking strength)	73.5 kN (7,500 kgf)
Wire rope(Construction)	7 x 7 + 6 x Fi (29)
Hook block	4 sheaves
HOOK STOWING DEVICE	Mechanically stowed beneath boom top portion
SLEWING	Hydraulic motor driven. Worm gear speed reduction. Continuous 360° full circle slewing on ball bearing slew ring. Automatic slewing lock.
Slewing speed	2.1 min-1 (rpm)
OUTRIGGERS	Hydraulically operated beams and jacks. Integral with crane frame
Extended width	Min.: 2,280 mm, Mid.: 3,900 mm, Max.: 5,500 mm (center to center)
HYDRAULIC SYSTEM	
Hydraulic pump	Single gear pump
Hydraulic motors	Axial piston type for winch and slewing
Control valves	Multiple control valves with integral safety valves
Oil tank capacity	approx. 102 liters
RADIO CONTROLLER*	Model : RCS-F (with colored display), Control functions of boom telescoping, hoisting up and down, boom elevating, slewing, acceleration, speed mode selection, working height limiting, Hook-in, Hook-out, horn and emergency stop, Basket mode
Frequency	40 frequencies in 433 MHz band
Operating power supply	
Transmitter	6V DC, Dry battery R6P(SUM-3) x 4
Control unit	24V DC, Vehicle battery
Transmitter mass	Approx. 670 g (includes batteries)
SAFETY DEVICES	<ul style="list-style-type: none"> •AML(Automatic Moment Limiter) <Load indication, Load moment ratio to rated load indication, Warning alarm, Over load limiter (alarm/stop) (safety eyes), Limit warning lamp, Outrigger length detector, Outrigger asymmetric extension width control> •WHL(Working Height Limiter) •Stop switch on radio controller* •Emergency stop switch •Over-winding alarm •Anti-two-block device •Hook safety latch •Hydraulic safety valves, check valves and holding valves •Boom angle indicator •Spirit level •Jack interlock •Over-unwinding prevention •Boom outrigger stowed warning •Limit warning lamp(three-color)
OPTIONAL EQUIPMENT	•Rear outriggers (outrigger beam extension type) •Rear outriggers (outrigger beam non-extension type) •Oil cooler •Basket mounting support* •Maintenance cock
CRANE MASS	Approx. 3,350 kg (except mounting parts)

Note: Each operating speeds show the value when there is no load conditions and the pump delivery is the following conditions.
 •36 L/min (Slewing speed) •60 L/min (BOOM:Extending speed, Raising speed WINCH:Single line speed)

*TM-ZX1205HRS only

Working Range (4 parts of line)

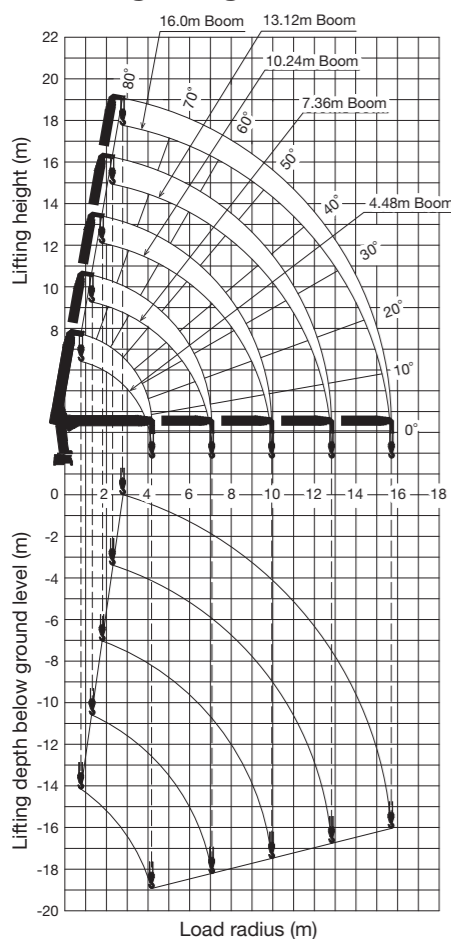

Note: The above lifting heights and boom angles are based on a straight (unladen) boom, and allowance should be made for boom deflection obtained under laden conditions.

Dimensions

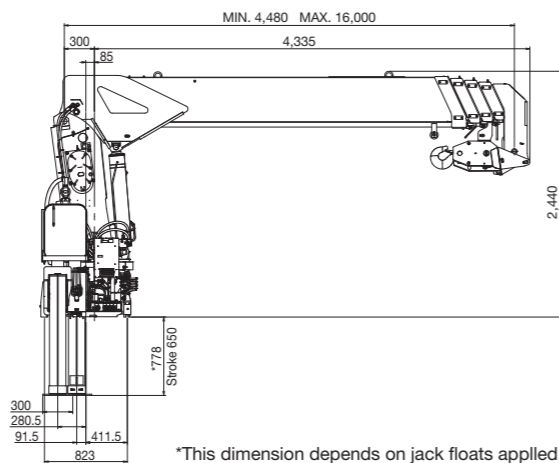

*This dimension depends on jack floats applied.

Rated Lifting Capacities (x 1,000 kg)

< over-side, over-rear area > (over-front area : 25% of empty chassis rated lifting capacity)

Table A

● 4.48 m boom		1.6 and below	2.5	3.0	3.3	3.5	4.18	
Load radius (m)		1.6 and below	2.5	3.0	3.3	3.5	4.18	
Crane Strength		12.00	8.80	7.00	6.10	5.70	4.70	
Empty Chassis	Extension width of outriggers	Max.	12.00	8.80	7.00	6.10	5.70	4.70
		Mid.	12.00	8.80	6.85	5.45	4.80	3.25
		Min.	10.00	3.80	2.65	2.20	1.95	1.35

Table B

● 7.36 m boom		2.5 and below	3.0	3.5	4.0	4.5	5.0	6.0	7.06	
Load radius (m)		2.5 and below	3.0	3.5	4.0	4.5	5.0	6.0	7.06	
Crane Strength		6.10	6.10	5.50	4.90	4.40	3.90	3.10	2.50	
Empty Chassis	Extension width of outriggers	Max.	6.10	6.10	5.50	4.90	4.40	3.65	2.50	1.75
		Mid.	6.10	6.10	4.65	3.50	2.75	2.20	1.50	1.04
		Min.	3.65	2.55	1.85	1.40	1.10	0.85	0.52	0.26

Table C

● 10.24 m boom		4.5 and below	5.0	6.0	7.0	8.0	9.0	10.0	11.0	12.0	12.82
Load radius (m)		4.5 and below	5.0	6.0	7.0	8.0	9.0	10.0	11.0	12.0	12.82
Crane Strength		3.30	3.20	2.90	2.50	2.10	1.85	1.55	1.30	1.10	1.00
Empty Chassis	Extension width of outriggers	Max.	3.30	3.20	2.90	2.50	2.10	1.85	1.55	1.30	1.10
		Mid.	3.30	3.20	2.40	1.75	1.40	1.10	0.90	0.70	0.55
		Min.	1.85	1.50	1.00	0.70	0.55	0.40	0.25	0.18	0.15

Table A

● 4.48 m boom		1.6 and below	2.5	3.0	3.3	3.5	4.18	
Load radius (m)		1.6 and below	2.5	3.0	3.3	3.5	4.18	
Crane Strength		12.00	8.80	7.00	6.10	5.70	4.70	
Empty Chassis	Extension width of outriggers	Max.	12.00	8.80	7.00	6.10	5.70	4.70
		Mid.	12.00	8.80	7.00	6.10	5.70	4.10
		Min.	12.00	4.65	3.30	2.75	2.45	1.70

Table B

● 7.36 m boom		2.5 and below	3.0	3.5	4.0	4.5	5.0	6.0	7.06	
Load radius (m)		2.5 and below	3.0	3.5	4.0	4.5	5.0	6.0	7.06	
Crane Strength		6.10	6.10	5.50	4.90	4.40	3.90	3.10	2.50	
Empty Chassis	Extension width of outriggers	Max.	6.10	6.10	5.50	4.90	4.40	3.90	3.10	2.25
		Mid.	6.10	6.10	5.50	4.40	3.50	2.90	2.05	1.45
		Min.	4.50	3.15	2.35	1.80	1.40	1.15	0.75	0.45

Table C

● 10.24 m boom		4.5 and below	5.0	6.0	7.0	8.0	9.0	10.0	11.0	12.0	12.82	
Load radius (m)		4.5 and below	5.0	6.0	7.0	8.0	9.0	10.0	11.0	12.0	12.82	
Crane Strength		3.30	3.20	2.90	2.50	2.10	1.85	1.55	1.30	1.10	1.00	
Empty Chassis	Extension width of outriggers	Max.	3.30	3.20	2.90	2.25	1.85	1.50	1.15	0.95	0.80	0.70
		Mid.	3.30	2.90	2.05	1.45	1.15	0.90	0.65	0.50	0.40	0.35
		Min.	1.40	1.15	0.75	0.45	0.25	-	-	-	-	-

- Notes:
- Rated capacity indicator issues warning with the limit warning lamp and the buzzer when the working state approaches limit or the strength limit.
 - When the AML is equipped with the rated capacity limiter, an operation stops automatically if the rated lifting capacity is exceeded.
 - When the crane is front mounted, set up the front outriggers so that the front wheels are slightly in contact with the ground. (If tire deformation is large, AML may activate earlier.)
 - Empty Chassis Rated Capacities in these tables depend on condition that crane is set level on firm level ground.
 - This value has been calculated on the basis of ISO 15442.
 - This value includes the mass of lifting devices such as hook block (95 kg).
 - This load radius shows actual load radius which includes boom deflection.
 - Rated lifting capacity is in consideration of the loading on the truck bed, and is within the range from the empty chassis rated lifting capacity to the crane strength rated lifting capacity.
 - If the boom length exceeds the table value even a little, the performance is limited to the performance of the next boom length.
 - When the boom length is 13.12 m, a half of the mark on lateral face of the 4th boom section is exposed out of 3rd boom section.
 - When the lifting load is heavier than 6,100 kg, number of part lines must be 8. In case of 6,100 kg or less, number of part lines must be 4. Load per line must not surpass 14.96 kN (1,525 kgf).

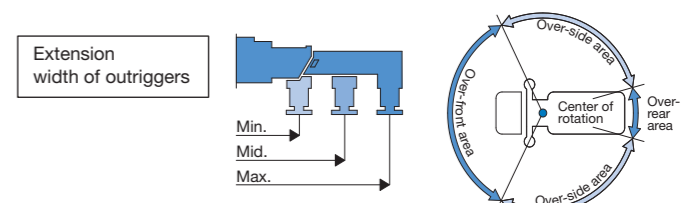

12. Empty chassis rated lifting capacity varies according to the working area.
 •Front mounting <over-side, over-rear area> : 100%
 •<over-front area> : 25% (*2) or 60% (*2) or 100% (*2)
 *2: Depend on the types of chassis.
 13. Empty Chassis Rated Capacities table A, B and C depend on the types of chassis. (The following table shows guidelines for bodywork vehicles that can achieve the rated lifting capacity tables A, B, and C for vehicles with front 1-axis and rear 2-axis. Be sure to carry out a stability inspection to determine which performance to apply.)

A	5500 mm ≤ WB (*3), 25 t ≤ GVW, 3.0 t ≤ CAWF (*4)
B	5500 mm ≤ WB (*3), 25 t ≤ GVW, 4.0 t ≤ CAWF (*4)
C	5500 mm ≤ WB (*3), 25 t ≤ GVW, 5.0 t ≤ CAWF (*4)

*3: From the front axle to the farthest rear axle.
 *4: Chassis front axle weight (excluding crane and mounting parts mass).

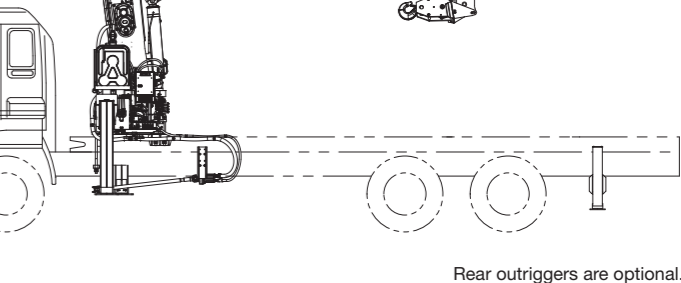

(mm)