



TADANO ROUGH TERRAIN CRANE

MODEL : GR-1450EX

(Left-hand steering)

GENERAL DATA

<u>CRANE CAPACITY</u>		145,000 kg at 2.5 m	
<u>BOOM</u>		6-section,	13.1 m — 61.0 m
<u>DIMENSION</u>			
Overall length	approx.		16,190 mm
Overall width	approx.		3,315 mm
Overall height	approx.		3,785 mm
<u>MASS</u>			
Gross vehicle mass	approx.		90,805 kg
-1st axle	approx.		28,701 kg
-2nd axle	approx.		30,814 kg
-3rd axle	approx.		31,290 kg
<u>PERFORMANCE</u>			
Max. traveling speed (with counterweight)	computed		15 km/h
Gradeability (tan θ) (with 18.2t counterweight)	computed		52 % (at stall) *30 %

* Machine should be operated within the limit of engine crankcase design (17° : MITSUBISHI 6M60-TL).

Specifications are subject to change without notice.

CRANE SPECIFICATIONS

<u>MODEL</u>	GR-1450EX
<u>CAPACITY</u>	145,000 kg at 2.5 m
<u>BOOM</u>	<p>Six sections extended by single telescoping cylinder, 13.1m~61.0m, of round box construction with 7 sheaves, 0.400m root diameter, at boom head.</p> <p>Hydraulic cylinders fitted with holding valves.</p> <p>Fully retracted length. 13.1 m</p> <p>Fully extended length. 61.0 m</p> <p>Extension speed. 47.9 m in 450 s</p>
<u>JIB</u>	<p>Two staged slewing around boom extension. Triple offset (0°/20°/40°)type. Stows alongside base boom section.</p> <p>Assistant cylinders for mounting and stowing.</p> <p>Single sheave at jib head.</p> <p>Length. 10.3 m and 18.0 m</p>
<u>SINGLE TOP (AUXILIARY BOOM SHEAVE)</u>	<p>Single sheave, 0.440m root diameter.</p> <p>Mounted to main boom head for single line work.</p>
<u>ELEVATION</u>	<p>By a double-acting hydraulic cylinder, fitted with holding valve.</p> <p>Automatic speed reduction and slow stop function.</p> <p>Boom angle -1.5° to 81.5°</p> <p>Boom raising speed 20° to 60° in 28 s</p>
<u>HOIST - Main winch</u>	<p>Variable speed type with grooved drum driven by hydraulic axial piston motor through winch speed reducer. Power load lowering and hoisting. Equipped with automatic brake (Neutral brake) and counterbalance valve. Controlled independently of auxiliary winch.</p> <p>Single line pull. 70.6 kN {7,200 kgf}</p> <p>Single line speed(High). 136 m/min (at the 4th layer)</p> <p>Single line speed(Low) 97 m/min (at the 4th layer)</p> <p>Wire rope. No-spin type</p> <p>Diameter x length. 19 mm x 320 m</p>
<u>HOOK BLOCK(Optional) - 100 t capacity</u>	8 sheaves, swivel type hook with safety latch.
<u>HOOK BLOCK(Optional) - 45 t capacity</u>	3 sheaves, swivel type hook with safety latch.

HOIST -Auxiliary winch

Variable speed type with grooved drum driven by hydraulic axial piston motor through winch speed reducer. Power load lowering and hoisting. Equipped with automatic brake (Neutral brake) and counterbalance valve. Controlled independently of main winch.

Single line pull. 70.6 kN {7,200 kgf}

Single line speed(High). 136 m/min (at the 4th layer)

Single line speed(Low) 97 m/min (at the 4th layer)

Wire rope. No-spin type

Diameter x length. 19 mm x 225 m

HOOK BLOCK (Optional) -7.2 t capacity

Swivel hook with safety latch for single line use.

SLEWING

Hydraulic axial piston motor driven through planetary speed reducer.

Continuous 360° full circle slewing on ball bearing slew ring.

Equipped with manually locked/released slewing brake.

Front positive slewing lock manually engaged in cab.

Twin slewing system: Free slewing or lock slewing controlled by selector switch on front console.

Slewing speed. 1.3 min⁻¹ {rpm}

HYDRAULIC SYSTEM

Pumps. Two variable piston pumps for crane functions.

Tandem gear pump for steering, slewing and optional equipment.

Control valves. . . . Multiple valves actuated by pilot pressure with integral pressure relief valves.

Circuit. Equipped with air cooled type oil cooler.

Oil pressure appears on AML display for main circuit.

Hydraulic oil tank capacity. . .

approx. 763 liters

Filters. Return line filter

CRANE CONTROL

By 4 control levers for slewing, boom elevation, main winch, boom telescoping or auxiliary winch with 2 control pedals for boom elevation and boom telescoping based on ISO standard layout. Control lever stands can change neutral positions and tilt for easy access to cab.

CAB

Both crane and drive operations can be performed from one cab mounted on rotating superstructure. 15° tilt, Left side, one-man type, steel construction with sliding door access and tinted safety glass windows opening at side. Door window is power controlled.

Operator's 3 way adjustable seat with headrest and armrest.

Air conditioner (Hot water heater and cooler).

TADANO Automatic
Moment Limiter
(Model: AML-C)

Main unit in crane cab gives audible and visual warning of approach to overload. Automatically cuts out crane motions before overload. With working range (load radius and/or boom angle and/or tip height and/or slewing range) limit function.

Automatic Speed Reduction and Slow Stop function on boom elevation and slewing.

Following functions are displayed.

- Load as percentage
- Number of parts of line of rope
- Boom angle
- Boom length
- Load radius
- Outriggers position
- On-tire indicator
- Actual hook load
- Permissible load
- Boom position indicator
- Potential hook height
- Slewing angle
- Main hydraulic oil pressure
- Jib length and jib offset angle (only when jib operation)

OUTRIGGERS

Hydraulically operated H-type outriggers. Each outrigger controlled simultaneously or independently from the cab.

Equipped with sight level gauge.

Floats can be stowed on vertical cylinders or removed to improve approach and departure angles.

All cylinders fitted with pilot check valves.

Crane operation with different extended length of each outrigger.

Equipped with extension width detector for each outrigger.

Outrigger unit is self-removable for ease of transportation.

- Extended width
 - Fully. 8,200 mm
 - Middle. 7,300 mm
 - Middle. 5,500 mm
 - Minimum. 2,990 mm
- Float size (Diameter). 570 mm

COUNTERWEIGHT

STANDARD..... 18.2t section. Hydraulically installed and removed.

OPTIONAL WEIGHT..... Additional 11.1t for a total of 29.3t.

NOTE : Each crane motion speed is based on unladen conditions.

CARRIER SPECIFICATIONS

<u>TYPE</u>	Rear engine, left hand steering, driving axle 2-way selected type by manual switch. 6x2 1st drive 6x4 1st and 3rd drive
<u>FRAME</u>	High-tensile steel, all welded mono-box construction.
<u>ENGINE</u>	Model. . . . Mitsubishi 6M60-TL Type. . . . 4 cycle, turbo charged and after cooled, 6 cylinder in line, direct injection, water cooled diesel engine. Piston displacement. . . . 7,540 cm ³ Bore x stroke. 118 mm x 115 mm Max. output. 200 kW at 2,600 min ⁻¹ {rpm} Max. torque. 785 N-m at 1,400 min ⁻¹ {rpm}
<u>TRANSMISSION</u>	Electronically controlled full automatic transmission. Torque converter driving full powershift with driving axle selector. 5 forward and 2 reverse speeds, constant mesh. 2 speeds - High range - 2 wheel drive ; 4 wheel drive 3 speeds - Low range - 4 wheel drive
<u>AXLES</u>	1st. Full floating type, steering and driving axle with planetary reduction and open differential. 2nd. Steering and not driving axle. 3rd. Full floating type, steering and driving axle with planetary reduction and open differential.
<u>STEERING</u>	Hydraulic power steering controlled by steering wheel. Four steering modes available: 2-wheel front 4-wheel rear 6-wheel coordinated 6-wheel crab
<u>SUSPENSION</u>	1st. Rigid mounted to frame. 2nd,3rd. . "Hydro-Pneumatic suspension cylinders" with leveling adjustment and oscillation.
<u>BRAKE SYSTEM</u>	Service. . . Air over hydraulic disc brakes on all 6 wheels. Parking / Emergency. . . Spring applied-air released brake acting on input shaft of 1st and 3rd axle. Auxiliary. . . Electro-pneumatic operated exhaust brake.
<u>ELECTRIC SYSTEM</u>	24 V DC. 2 batteries of 12 V - 120 Ah capacity.
<u>FUEL TANK CAPACITY</u>	300 liters
<u>TIRES</u>	26.5R25 ,Air pressure:650kPa
<u>TURN RADIUS</u>	Min. turning radius (at center of extreme outer tire) 2-wheel steering. 14.9 m 6-wheel steering. 9.9 m

EQUIPMENT

STANDARD EQUIPMENT

Anti-two-block device
 External lamp (AML)
 Winch drum mirror
 Tadano twin slewing system and front positive slewing lock
 Winch automatic fail-safe brake
 Winch drum rotation indicator (Visual type)
 2-speed hoist
 Hook safety latch
 Pilot check valves
 Holding valves
 Counterbalance valves
 Hydraulic pressure relief valves
 Slewing brake
 Positive control
 Hydraulic oil cooler
 Air conditioner (Hot water heater and cooler)
 Electric windshield wiper and washer
 Roof window wiper and washer
 Power window (Cab door)
 Tachometer/Speedometer
 3 way adjustable cloth seat with seat belt, headrest and armrest
 Cab floor mat
 Sun visor (Front and roof)
 Tilt-telescope steering wheel
 Boom elevation foot pedal
 Boom telescoping foot pedal
 Parking braked travel warning
 Automatic moment limiter (AML)
 Boom angle indicator
 Outrigger extension width detector
 Sight level gauge
 Automatic drive system
 Transmission neutral position engine start
 Overshift prevention
 Back-up alarm
 Air cleaner dust indicator
 Air dryer
 Water separator with filter
 Towing eyes - front and rear
 Engine over-run alarm
 Telematics (machine data logging and monitoring system) with -
 HELLO-NET via internet (availability depends on countries)
 Fuel consumption monitor
 Eco mode system
 15° tilt cab
 Tare function
 Self-removable outrigger unit
 Self-removable counterweight

OPTIONAL EQUIPMENT

Additional weight 11.1t
 Removable boom system
 Hook block - 100t capacity (8 sheaves, swivel type with safety latch. Mass : approx. 1,080 kg)
 Hook block - 45t capacity (3 sheaves, swivel type with safety latch. Mass : approx. 610 kg)
 Hook block – 7.2t capacity (Swivel type with safety latch for single line use. Mass : approx. 300 kg)
 Working lamp with remote controller
 Boom and jib mounted aircraft warning light
 Anemometer
 Emergency steering
 Over-unwinding prevention
 Tire inflation kit

HOISTING PERFORMANCE

Layer	Main or auxiliary hoist 0.362m drum 19mm wire rope	
	Line pulls	drum grooved lagging
	Low	Total wire rope
	N(kgf)	Meters
1st	97,000(9,900)	44.8
2nd	88,300(9,010)	93.4
3rd	81,100(8,270)	145.9
4th	74,900(7,640)	202.2
5th	69,500(7,090)	262.3
6th	64,900(6,620)	326.2
7th ¹	60,800(6,210)	393.9

¹Seventh layer of wire rope is not recommended for hoisting operations.

GR-1450EX RATED LIFTING CAPACITIES(IN METRIC TON)

Boom

ISO 4305

COUNTERWEIGHT 29.3t ON OUTRIGGERS FULLY EXTENDED 8.2m SPREAD 360° ROTATION (Unit:×1,000kg)												
A \ B	13.1m	17.4m	21.8m	26.2m	30.6m	35.0m	39.4m	43.8m	48.2m	52.6m	57.0m	61.0m
2.50	**145.0	90.7	79.0									
3.00	*110.6	90.7	79.0	37.0								
3.50	*101.5	90.7	79.0	66.0								
4.00	93.6	90.1	79.0	66.0	37.0							
4.50	85.9	83.7	79.0	66.0	48.2							
5.00	79.3	78.1	75.8	66.0	48.2	35.2						
5.50	73.5	73.2	71.0	66.0	48.2	35.2						
6.00	68.3	68.3	66.7	63.5	48.2	38.7						
6.50	63.7	64.1	63.6	60.5	48.2	37.5	30.1					
7.00	59.6	60.0	60.2	57.8	48.2	35.9	30.1					
7.50	56.0	56.4	56.5	55.3	48.2	35.2	30.1	22.1				
8.00	52.7	53.1	53.2	52.9	48.0	35.2	29.5	23.9				
9.00	46.8	47.3	47.5	47.2	44.8	35.2	27.9	23.9	17.2			
10.00	37.3	41.7	41.9	41.6	41.6	35.2	26.2	22.9	18.9	13.5		
11.00		37.1	37.3	37.5	37.7	33.2	24.4	22.0	18.9	15.0		
12.00		33.4	33.5	34.3	33.9	31.5	22.7	21.0	18.4	15.0	12.0	
14.00		27.8	27.6	28.4	28.0	28.4	20.9	19.2	16.9	15.0	12.0	10.4
16.00			23.3	24.0	24.3	24.3	19.3	17.1	15.5	14.1	12.0	10.4
18.00			21.2	20.2	21.3	20.7	17.8	15.4	14.3	13.1	12.0	10.4
20.00				18.1	17.8	17.3	16.5	14.0	12.9	12.1	11.2	10.2
22.00				15.4	15.2	14.6	15.2	12.7	11.8	11.2	10.4	9.6
24.00					13.0	13.6	13.1	11.7	10.8	10.4	9.8	9.0
26.00					11.3	11.9	11.4	10.8	10.1	9.6	9.1	8.4
28.00					8.2	10.5	9.9	9.6	9.4	8.8	8.5	7.8
30.00						9.3	8.7	9.1	8.6	8.2	8.0	7.3
32.00						8.3	7.7	8.0	7.5	7.7	7.4	6.7
34.00							6.8	7.1	6.9	7.0	6.6	6.2
36.00							6.1	6.3	6.5	6.2	5.8	5.8
38.00								5.9	5.8	5.5	5.1	5.1
40.00								5.5	5.2	4.9	4.5	4.5
42.00									4.6	4.4	3.9	3.9
44.00									4.2	3.9	3.4	3.4
46.00										3.4	3.0	3.0
48.00										3.1	2.6	2.6
50.00										2.7	2.2	2.2
52.00											1.9	1.9
54.00											1.7	1.6
56.00												1.3

**Over front with special Equipment
*With special Equipment

A :Boom length (m)
B :Load radius (m)

In this table, the thick line which divides strength area and stability area is not shown because the figure of this table is indicated the best performance at the same boom length among the plural telescopic boom patterns.

GR-1450EX RATED LIFTING CAPACITIES

ISO 4305

Jib

61.0m Boom + 10.3m Manual offset jib							57.0m Boom + 10.3m Manual offset jib						
C	0° Tilt		20° Tilt		40° Tilt		C	0° Tilt		20° Tilt		40° Tilt	
	R	W	R	W	R	W		R	W	R	W	R	W
81.5	13.2	5.5	17.3	5.5	20.3	5.2	81.5	11.8	6.2	15.7	6.2	18.6	5.8
81	13.9	5.5	18.1	5.5	21.0	5.1	81	12.5	6.2	16.5	6.2	19.2	5.8
80	15.9	5.5	19.7	5.4	22.4	4.9	80	14.0	6.2	18.0	6.2	20.5	5.6
79	17.2	5.5	21.3	5.3	23.7	4.8	79	15.5	6.2	19.2	6.0	21.7	5.4
78	18.8	5.5	22.5	5.1	25.1	4.7	78	16.9	6.2	20.5	5.8	22.9	5.3
77	20.3	5.5	23.8	4.9	26.3	4.5	77	18.4	6.2	21.8	5.6	24.1	5.1
76	21.9	5.5	25.3	4.8	27.6	4.4	76	19.8	6.2	23.1	5.5	25.3	5.0
75	23.3	5.3	26.6	4.7	28.8	4.3	75	21.1	6.1	24.3	5.3	26.5	4.9
73	26.1	5.0	29.2	4.4	31.2	4.1	73	23.6	5.7	26.7	5.0	28.7	4.6
70	29.8	4.5	32.9	4.1	34.6	3.8	70	27.2	5.2	30.1	4.6	31.9	4.3
68	32.3	4.3	35.2	3.9	36.8	3.6	68	29.4	4.9	32.4	4.4	34.0	4.1
65	35.9	4.0	38.6	3.6	39.9	3.4	65	32.7	4.5	35.6	4.1	37.0	3.9
63	38.0	3.7	40.8	3.5	42.0	3.3	63	35.0	4.3	37.5	3.9	38.9	3.7
60	41.3	3.4	43.7	3.2	45.0	3.1	60	38.0	4.0	40.5	3.7	41.8	3.6
58	43.4	3.2	45.8	3.0	46.7	2.9	58	40.1	3.9	42.5	3.6	43.4	3.4
55	46.4	3.0	48.6	2.8	49.4	2.7	55	42.9	3.6	45.2	3.4	46.1	3.3
53	48.2	2.8	50.4	2.7	51.1	2.6	53	44.6	3.4	46.9	3.3	47.6	3.2
50	50.8	2.5	52.6	2.3	53.1	2.2	50	47.2	3.2	49.1	3.0	49.6	2.8
48	52.2	2.2	54.0	2.0	54.5	1.9	48	48.7	2.9	50.5	2.7	50.9	2.6
45	54.3	1.8	56.1	1.7	56.4	1.6	45	50.7	2.4	52.4	2.3	52.8	2.2
43	55.7	1.6	57.3	1.4			43	52.1	2.2	53.6	2.0		
40	57.7	1.3	59.2	1.2			40	54.0	1.8	55.4	1.7		
38	58.9	1.1	60.2	1.0			38	55.2	1.6	56.4	1.5		
35	60.8	0.9	61.8	0.8			35	56.9	1.4	58.0	1.3		
33							33	57.9	1.2	58.9	1.2		
30							30	59.5	1.1	60.0	1.0		
28							28	60.3	0.9	60.9	0.9		
25							25	61.5	0.8	61.9	0.8		
E				1			E				1		

52.6m Boom + 10.3m Manual offset jib							35.0m Boom + 10.3m Manual offset jib						
C	0° Tilt		20° Tilt		40° Tilt		C	0° Tilt		20° Tilt		40° Tilt	
	R	W	R	W	R	W		R	W	R	W	R	W
81.5	10.3	7.2	14.3	7.2	17.3	6.8	81.5			8.9	10.6	11.3	7.3
81	10.9	7.2	14.9	7.2	17.9	6.7	81			9.3	10.5	11.7	7.2
80	12.3	7.2	16.3	7.2	19.1	6.5	80			10.1	10.2	12.5	7.1
79	13.7	7.2	17.6	7.1	20.2	6.3	79			10.9	10.0	13.2	7.0
78	15.0	7.2	18.8	6.9	21.4	6.1	78			11.9	9.7	14.0	6.9
77	16.4	7.2	19.7	6.6	22.5	6.0	77			12.6	9.5	14.8	6.9
76	17.6	7.2	21.1	6.4	23.5	5.8	76			13.3	9.3	15.5	6.8
75	19.0	7.2	22.2	6.2	24.6	5.7	75	11.3	14.1	14.1	9.1	16.2	6.7
73	21.3	6.8	24.4	5.9	26.7	5.4	73	12.9	13.2	15.6	8.7	17.6	6.5
70	24.8	6.2	27.7	5.4	29.6	5.0	70	15.2	12.2	17.9	8.2	19.6	6.3
68	26.9	5.9	29.7	5.2	31.5	4.8	68	16.7	11.6	19.3	7.9	21.0	6.2
65	30.1	5.4	32.7	4.9	34.3	4.6	65	18.9	10.8	21.4	7.6	22.9	6.1
63	32.1	5.2	34.6	4.7	36.0	4.4	63	20.3	10.4	22.8	7.4	24.2	6.0
60	35.0	4.8	37.4	4.4	38.7	4.2	60	22.4	9.9	24.8	7.1	26.0	5.9
58	36.8	4.5	39.2	4.2	40.4	4.1	58	23.7	9.6	26.0	6.9	27.2	5.8
55	39.5	4.2	41.6	4.0	42.6	3.8	55	25.7	9.1	27.8	6.7	28.9	5.8
53	41.1	4.0	43.2	3.8	44.1	3.7	53	26.8	8.7	29.0	6.5	29.9	5.7
50	43.6	3.8	45.4	3.5	46.0	3.4	50	28.6	8.3	30.6	6.4	31.5	5.7
48	44.9	3.4	46.6	3.2	47.2	3.1	48	29.7	8.0	31.7	6.3	32.4	5.7
45	46.8	2.9	48.5	2.7	48.9	2.6	45	31.4	7.7	33.2	6.1	33.8	5.6
43	48.1	2.7	49.6	2.5			43	32.4	7.5	34.1	6.1		
40	49.9	2.3	51.2	2.1			40	33.9	7.2	35.5	6.0		
38	51.1	2.1	52.3	1.9			38	34.9	6.9	36.3	5.9		
35	52.9	1.8	54.0	1.7			35	36.1	6.4	37.5	5.9		
33	53.8	1.6	54.9	1.5			33	36.9	6.1	38.1	5.8		
30	55.3	1.4	56.1	1.3			30	38.1	5.7	39.1	5.4		
28	56.1	1.3	56.8	1.2			28	38.7	5.4	39.7	5.2		
25	57.3	1.1	57.7	1.1			25	39.7	5.2	40.4	5.0		
23	57.9	1.0					23	40.3	5.0				
20	58.8	0.9					20	41.0	4.8				
E				1			E				2		

C : Loaded boom angle (°)
R : Load radius (m)
W : Rated lifting capacity (Unit:×1,000kg)
E : Number of parts of line

GR-1450EX RATED LIFTING CAPACITIES

ISO 4305

Jib

COUNTERWEIGHT 29.3t ON OUTRIGGERS FULLY EXTENDED 8.2m SPREAD 360° ROTATION							COUNTERWEIGHT 29.3t ON OUTRIGGERS FULLY EXTENDED 8.2m SPREAD 360° ROTATION						
C	61.0m Boom + 18.0m Manual offset jib						C	57.0m Boom + 18.0m Manual offset jib					
	0° Tilt		20° Tilt		40° Tilt			0° Tilt		20° Tilt		40° Tilt	
	R	W	R	W	R	W		R	W	R	W	R	W
81.5	15.1	3.7	22.4	3.7	27.2	3.2	81.5	13.3	4.0	20.2	4.0	24.8	3.3
81	16.1	3.7	23.0	3.7	28.2	3.2	81	14.1	4.0	21.1	4.0	25.6	3.3
80	17.7	3.7	25.0	3.7	29.6	3.1	80	15.7	4.0	22.7	4.0	27.1	3.3
79	19.6	3.7	26.7	3.7	31.2	3.1	79	17.3	4.0	24.2	3.9	28.3	3.2
78	21.5	3.7	28.3	3.6	32.6	3.0	78	19.0	4.0	25.7	3.8	29.8	3.2
77	23.0	3.7	29.8	3.5	34.0	3.0	77	20.6	4.0	27.1	3.7	31.0	3.1
76	24.9	3.7	31.4	3.4	35.4	3.0	76	22.2	4.0	28.6	3.7	32.4	3.1
75	26.6	3.7	32.7	3.3	36.6	2.9	75	23.8	4.0	30.0	3.6	33.6	3.1
73	29.7	3.7	35.5	3.1	39.3	2.9	73	26.9	4.0	32.7	3.5	36.0	3.0
70	33.9	3.4	39.3	2.9	42.8	2.7	70	31.3	4.0	36.6	3.3	39.5	2.9
68	36.7	3.3	41.9	2.8	45.1	2.6	68	34.0	3.8	39.1	3.2	41.6	2.8
65	40.6	3.0	45.6	2.6	48.2	2.4	65	37.7	3.5	42.5	3.0	44.8	2.8
63	43.3	2.9	47.9	2.5	50.5	2.4	63	40.2	3.4	44.7	2.9	46.8	2.7
60	46.8	2.6	51.3	2.4	53.3	2.2	60	43.6	3.1	48.0	2.8	49.8	2.6
58	49.2	2.5	53.3	2.2	55.3	2.2	58	45.9	3.0	50.0	2.7	51.5	2.5
55	52.4	2.3	56.3	2.1	57.8	2.0	55	49.0	2.8	52.8	2.5	54.1	2.4
53	54.3	2.1	58.0	1.9	59.1	1.7	53	50.9	2.6	54.6	2.4	55.5	2.2
50	56.8	1.7	60.1	1.5	60.9	1.3	50	53.5	2.3	56.8	2.0	57.4	1.9
48	58.6	1.5	61.7	1.3	62.2	1.1	48	55.0	2.0	58.2	1.8	58.6	1.6
45	60.8	1.1	63.7	1.0	64.1	0.9	45	57.3	1.7	60.2	1.5	60.4	1.3
43	62.3	0.9	64.9	0.8			43	58.8	1.5	61.4	1.3		
40							40	60.8	1.2	63.1	1.0		
38							38	62.1	1.0	64.3	0.9		
35							35	64.0	0.8				
E			1				E			1			

COUNTERWEIGHT 29.3t ON OUTRIGGERS FULLY EXTENDED 8.2m SPREAD 360° ROTATION							COUNTERWEIGHT 29.3t ON OUTRIGGERS FULLY EXTENDED 8.2m SPREAD 360° ROTATION						
C	52.6m Boom + 18.0m Manual offset jib						C	35.0m Boom + 18.0m Manual offset jib					
	0° Tilt		20° Tilt		40° Tilt			0° Tilt		20° Tilt		40° Tilt	
	R	W	R	W	R	W		R	W	R	W	R	W
81.5	12.0	4.7	18.7	4.4	23.2	3.4	81.5	7.4	6.4	13.3	5.4	18.0	3.7
81	12.8	4.7	19.4	4.4	23.8	3.4	81	8.0	6.4	13.7	5.3	18.4	3.7
80	14.3	4.7	20.9	4.3	25.3	3.4	80	9.0	6.4	14.7	5.2	19.3	3.6
79	15.9	4.7	22.2	4.2	26.5	3.3	79	10.2	6.4	15.7	5.1	20.1	3.6
78	17.3	4.7	23.5	4.1	27.7	3.3	78	11.1	6.4	16.6	5.0	20.9	3.6
77	18.8	4.7	24.9	4.0	28.9	3.3	77	12.1	6.4	17.5	4.8	21.7	3.5
76	20.1	4.7	26.2	3.9	30.1	3.2	76	13.0	6.4	18.5	4.7	22.5	3.5
75	21.7	4.7	27.5	3.9	31.2	3.2	75	14.0	6.4	19.3	4.6	23.4	3.5
73	24.7	4.7	30.0	3.7	33.4	3.1	73	15.8	6.4	21.2	4.5	24.9	3.4
70	28.7	4.7	33.7	3.6	36.7	3.0	70	18.7	6.3	22.7	4.2	27.1	3.3
68	31.2	4.5	36.1	3.5	38.8	3.0	68	20.3	6.0	25.4	4.1	28.5	3.2
65	34.8	4.2	39.4	3.3	41.6	2.9	65	22.9	5.6	27.8	3.9	30.7	3.2
63	37.0	4.0	41.4	3.2	43.5	2.9	63	24.6	5.3	29.4	3.8	32.0	3.2
60	40.3	3.8	44.5	3.1	46.3	2.8	60	27.1	5.0	31.6	3.6	34.0	3.1
58	42.3	3.6	46.4	3.1	48.1	2.8	58	28.7	4.8	33.0	3.6	35.3	3.1
55	45.3	3.3	49.3	3.0	50.6	2.8	55	30.9	4.6	35.0	3.4	37.1	3.1
53	47.1	3.2	51.0	2.9	52.0	2.7	53	32.4	4.4	36.5	3.4	38.1	3.0
50	49.7	2.8	53.2	2.5	53.8	2.3	50	34.5	4.2	38.3	3.3	39.7	3.0
48	51.3	2.5	54.5	2.2	55.0	2.0	48	35.9	4.1	39.6	3.3	40.7	3.0
45	53.6	2.1	56.4	1.8	56.7	1.7	45	37.7	3.9	41.1	3.2	42.0	3.0
43	55.1	1.9	57.7	1.6			43	39.0	3.8	42.2	3.2		
40	57.1	1.6	59.5	1.4			40	40.7	3.7	43.7	3.1		
38	58.5	1.4	60.6	1.2			38	41.8	3.6	44.5	3.1		
35	60.4	1.1	62.1	1.0			35	43.3	3.5	45.8	3.1		
33	61.7	1.0	63.0	0.9			33	44.3	3.4	46.5	3.1		
30	63.3	0.8					30	45.7	3.3	47.5	3.1		
28							28	46.5	3.3	48.1	3.1		
25							25	47.6	3.2	48.8	3.1		
23							23	48.3	3.2				
20							20	49.1	3.1				
E			1				E			1			

C :Loaded boom angle (°)

R :Load radius (m)

W :Rated lifting capacity (Unit:x1,000kg)

E :Number of parts of line

GR-1450EX RATED LIFTING CAPACITIES

ISO 4305

Jib

COUNTERWEIGHT 18.2t ON OUTRIGGERS FULLY EXTENDED 8.2m SPREAD 360° ROTATION							COUNTERWEIGHT 18.2t ON OUTRIGGERS FULLY EXTENDED 8.2m SPREAD 360° ROTATION						
C	61.0m Boom + 10.3m Manual offset jib						C	57.0m Boom + 10.3m Manual offset jib					
	0° Tilt		20° Tilt		40° Tilt			0° Tilt		20° Tilt		40° Tilt	
	R	W	R	W	R	W		R	W	R	W	R	W
81.5	13.2	5.5	17.3	5.5	20.3	5.2	81.5	11.8	6.2	15.7	6.2	18.6	5.8
81	13.9	5.5	18.1	5.5	21.0	5.1	81	12.5	6.2	16.5	6.2	19.2	5.8
80	15.9	5.5	19.7	5.4	22.4	4.9	80	14.0	6.2	18.0	6.2	20.5	5.6
79	17.2	5.5	21.3	5.3	23.7	4.8	79	15.5	6.2	19.2	6.0	21.7	5.4
78	18.8	5.5	22.5	5.1	25.1	4.7	78	16.9	6.2	20.5	5.8	22.9	5.3
77	20.3	5.5	23.8	4.9	26.3	4.5	77	18.4	6.2	21.8	5.6	24.1	5.1
76	21.9	5.5	25.3	4.8	27.6	4.4	76	19.8	6.2	23.1	5.5	25.3	5.0
75	23.3	5.3	26.6	4.7	28.8	4.3	75	21.1	6.1	24.3	5.3	26.5	4.9
73	26.1	5.0	29.2	4.4	31.2	4.1	73	23.6	5.7	26.7	5.0	28.7	4.6
70	29.8	4.5	32.9	4.1	34.6	3.8	70	27.2	5.2	30.1	4.6	31.9	4.3
68	32.3	4.3	35.2	3.9	36.8	3.6	68	29.4	4.9	32.4	4.4	34.0	4.1
65	35.9	4.0	38.6	3.6	39.9	3.4	65	32.7	4.5	35.6	4.1	37.0	3.9
63	37.8	3.6	46.7	3.2	41.8	3.0	63	35.0	4.3	37.5	3.9	38.7	3.7
60	40.4	2.7	43.0	2.5	44.2	2.3	60	38.7	3.5	40.0	3.2	41.2	3.0
58	42.2	2.3	44.6	2.1	45.9	1.9	58	40.3	3.0	41.7	2.7	42.6	2.6
55	44.8	1.7	47.3	1.5	48.3	1.5	55	42.8	2.4	44.0	2.2	45.1	2.1
53	46.5	1.4	48.8	1.2	49.8	1.2	53	44.4	2.0	45.6	1.8	46.4	1.7
50	49.0	1.0	51.1	0.9	51.9	0.8	50	46.6	1.6	47.8	1.4	48.6	1.3
48							48	48.2	1.3	49.2	1.2	49.9	1.1
45							45	50.3	0.9	51.3	0.8	51.8	0.8
E	1						E	1					

COUNTERWEIGHT 18.2t ON OUTRIGGERS FULLY EXTENDED 8.2m SPREAD 360° ROTATION							COUNTERWEIGHT 18.2t ON OUTRIGGERS FULLY EXTENDED 8.2m SPREAD 360° ROTATION						
C	52.6m Boom + 10.3m Manual offset jib						C	35.0m Boom + 10.3m Manual offset jib					
	0° Tilt		20° Tilt		40° Tilt			0° Tilt		20° Tilt		40° Tilt	
	R	W	R	W	R	W		R	W	R	W	R	W
81.5	10.3	7.2	14.3	7.2	17.3	6.8	81.5			8.9	10.6	11.3	7.3
81	10.9	7.2	14.9	7.2	17.9	6.7	81			9.3	10.5	11.7	7.2
80	12.3	7.2	16.3	7.2	19.1	6.5	80			10.1	10.2	12.5	7.1
79	13.7	7.2	17.6	7.1	20.2	6.3	79			10.9	10.0	13.2	7.0
78	15.0	7.2	18.8	6.9	21.4	6.1	78			11.9	9.7	14.0	6.9
77	16.4	7.2	19.7	6.6	22.5	6.0	77			12.6	9.5	14.8	6.9
76	17.6	7.2	21.1	6.4	23.5	5.8	76			13.3	9.3	15.5	6.8
75	19.0	7.2	22.2	6.2	24.6	5.7	75	11.3	14.1	14.1	9.1	16.2	6.7
73	21.3	6.8	24.4	5.9	26.7	5.4	73	12.9	13.2	15.6	8.7	17.6	6.5
70	24.8	6.2	27.7	5.4	29.6	5.0	70	15.2	12.2	17.9	8.2	19.6	6.3
68	26.9	5.9	29.7	5.2	31.5	4.8	68	16.7	11.6	19.3	7.9	21.0	6.2
65	30.1	5.4	32.7	4.9	34.3	4.6	65	18.9	10.8	21.4	7.6	22.9	6.1
63	32.1	5.2	34.6	4.7	36.0	4.4	63	20.3	10.4	22.8	7.4	24.2	6.0
60	35.6	4.3	37.0	3.8	38.3	3.6	60	22.4	9.9	24.8	7.1	26.0	5.9
58	37.1	3.7	38.5	3.3	39.7	3.1	58	23.7	9.6	26.0	6.9	27.2	5.8
55	39.5	3.0	40.9	2.7	41.9	2.5	55	25.7	9.1	27.8	6.7	28.9	5.8
53	41.0	2.5	42.3	2.3	43.2	2.2	53	26.8	8.3	29.0	6.5	29.9	5.7
50	43.2	2.0	44.6	1.8	45.3	1.7	50	28.5	7.2	30.6	6.4	31.5	5.7
48	44.6	1.7	45.8	1.6	46.5	1.5	48	29.6	6.7	31.8	6.1	32.4	5.7
45	46.7	1.3	47.7	1.2	48.3	1.1	45	31.2	5.9	33.1	5.5	33.7	5.3
43	47.2	1.1	49.0	1.0			43	32.2	5.5	34.0	5.1		
40	49.2	0.8					40	33.6	4.9	35.3	4.6		
38							38	34.5	4.6	36.1	4.3		
35							35	35.9	4.2	37.3	4.0		
33							33	36.7	4.0	38.0	3.8		
30							30	37.8	3.6	39.0	3.5		
28							28	38.5	3.5	39.5	3.3		
25							25	39.5	3.2	40.3	3.1		
23							23	40.1	3.1				
20							20	40.4	2.9				
E	1						E	2					

C :Loaded boom angle (°)
R :Load radius (m)
W :Rated lifting capacity (Unit:x1,000kg)
E :Number of parts of line

GR-1450EX RATED LIFTING CAPACITIES

ISO 4305

Jib

COUNTERWEIGHT 18.2t ON OUTRIGGERS FULLY EXTENDED 8.2m SPREAD 360° ROTATION													
C	61.0m Boom + 18.0m Manual offset jib						C	57.0m Boom + 18.0m Manual offset jib					
	0° Tilt		20° Tilt		40° Tilt			0° Tilt		20° Tilt		40° Tilt	
	R	W	R	W	R	W		R	W	R	W	R	W
81.5	15.1	3.7	22.4	3.7	27.2	3.2	81.5	13.3	4.0	20.2	4.0	24.8	3.3
81	16.1	3.7	23.0	3.7	28.2	3.2	81	14.1	4.0	21.1	4.0	25.6	3.3
80	17.7	3.7	25.0	3.7	29.6	3.1	80	15.7	4.0	22.7	4.0	27.1	3.3
79	19.6	3.7	26.7	3.7	31.2	3.1	79	17.3	4.0	24.2	3.9	28.3	3.2
78	21.5	3.7	28.3	3.6	32.6	3.0	78	19.0	4.0	25.7	3.8	29.8	3.2
77	23.0	3.7	29.8	3.5	34.0	3.0	77	20.6	4.0	27.1	3.7	31.0	3.1
76	24.9	3.7	31.4	3.4	35.4	3.0	76	22.2	4.0	28.6	3.7	32.4	3.1
75	26.6	3.7	32.7	3.3	36.6	2.9	75	23.8	4.0	30.0	3.6	33.6	3.1
73	29.7	3.7	35.5	3.1	39.3	2.9	73	26.9	4.0	32.7	3.5	36.0	3.0
70	33.9	3.4	39.3	2.9	42.8	2.7	70	31.3	4.0	36.6	3.3	39.5	2.9
68	36.7	3.3	41.9	2.8	45.1	2.6	68	34.0	3.8	39.1	3.2	41.6	2.8
65	40.6	3.0	45.5	2.6	48.2	2.2	65	37.7	3.5	42.5	3.0	44.8	2.8
63	42.6	2.6	47.4	2.1	49.7	1.9	63	40.2	3.3	44.6	2.7	46.5	2.4
60	45.5	1.9	50.0	1.6	52.1	1.4	60	42.8	2.5	47.1	2.1	49.0	1.9
58	47.4	1.5	51.6	1.2	53.8	1.1	58	44.7	2.1	48.8	1.8	50.6	1.6
55	50.2	1.0	54.3	0.8			55	47.4	1.6	51.2	1.3	52.8	1.2
53	52.2	0.8					53	49.1	1.3	52.9	1.1	54.2	0.9
50							50	51.7	0.9				
E			1				E			1			

COUNTERWEIGHT 18.2t ON OUTRIGGERS FULLY EXTENDED 8.2m SPREAD 360° ROTATION													
C	52.6m Boom + 18.0m Manual offset jib						C	35.0m Boom + 18.0m Manual offset jib					
	0° Tilt		20° Tilt		40° Tilt			0° Tilt		20° Tilt		40° Tilt	
	R	W	R	W	R	W		R	W	R	W	R	W
81.5	12.0	4.7	18.7	4.4	23.2	3.4	81.5	7.4	6.4	13.3	5.4	18.0	3.7
81	12.8	4.7	19.4	4.4	23.8	3.4	81	8.0	6.4	13.7	5.3	18.4	3.7
80	14.3	4.7	20.9	4.3	25.3	3.4	80	9.0	6.4	14.7	5.2	19.3	3.6
79	15.9	4.7	22.2	4.2	26.5	3.3	79	10.2	6.4	15.7	5.1	20.1	3.6
78	17.3	4.7	23.5	4.1	27.7	3.3	78	11.1	6.4	16.6	5.0	20.9	3.6
77	18.8	4.7	24.9	4.0	28.9	3.3	77	12.1	6.4	17.5	4.8	21.7	3.5
76	20.1	4.7	26.2	3.9	30.1	3.2	76	13.0	6.4	18.5	4.7	22.5	3.5
75	21.7	4.7	27.5	3.9	31.2	3.2	75	14.0	6.4	19.3	4.6	23.4	3.5
73	24.7	4.7	30.0	3.7	33.4	3.1	73	15.8	6.4	21.2	4.5	24.9	3.4
70	28.7	4.7	33.7	3.6	36.7	3.0	70	18.7	6.3	22.7	4.2	27.1	3.3
68	31.2	4.5	36.1	3.5	38.8	3.0	68	20.3	6.0	25.4	4.1	28.5	3.2
65	34.8	4.2	39.4	3.3	41.6	2.9	65	22.9	5.6	27.8	3.9	30.7	3.2
63	36.9	4.0	41.4	3.2	43.5	2.9	63	24.6	5.3	29.4	3.8	32.0	3.2
60	39.5	3.1	44.1	2.6	46.3	2.3	60	27.1	5.0	31.6	3.6	34.0	3.1
58	41.4	2.7	45.8	2.2	47.7	2.0	58	28.7	4.8	33.0	3.6	35.3	3.1
55	44.1	2.1	48.2	1.7	49.8	1.5	55	30.9	4.6	35.0	3.4	37.1	3.1
53	45.8	1.7	49.7	1.4	51.3	1.3	53	32.4	4.4	36.5	3.4	38.1	3.0
50	48.5	1.3	52.1	1.1	53.1	0.9	50	34.5	4.2	38.3	3.3	39.7	3.0
48	50.2	1.0	53.5	0.8			48	35.9	4.1	39.6	3.3	40.7	3.0
45							45	37.7	3.9	41.1	3.2	42.0	3.0
43							43	39.0	3.8	42.2	3.2		
40							40	40.7	3.7	43.7	3.1		
38							38	41.7	3.4	44.5	3.1		
35							35	43.2	3.1	45.7	2.8		
33							33	44.3	2.9	46.4	2.7		
30							30	45.5	2.7	47.4	2.5		
28							28	46.3	2.5	47.9	2.3		
25							25	47.4	2.3	48.6	2.2		
23							23	48.1	2.2				
20							20	48.9	2.1				
E			1				E			1			

C :Loaded boom angle (°)
R :Load radius (m)
W :Rated lifting capacity (Unit:x1,000kg)
E :Number of parts of line

NOTES FOR "ON OUTRIGGERS" TABLE

- Rated lifting capacities shown in the table are based on condition that crane is set on firm level surface. Those above thick lines are based on crane strength and those below, on its stability. (Excluding the table shown in page 8)
- Rated lifting capacities based on crane stability are according to ISO4305.
- The mass of the hook (1,080 kg for 100t capacity, 610 kg for 45t capacity, 300 kg for 7.2 t capacity), slings and all similarly used load handling devices must be considered as part of the load and must be deducted from the lifting capacities.
- For rated lifting capacity of single top, reduce the rated lifting capacities of relevant boom according to a weight reduction for auxiliary load handling equipment. Capacities of single top shall not exceed 7,200 kg including main boom hook mass and the net capacity must be so reduced.
- Standard number of parts of line for each boom length is as shown below. Load per line should not surpass 70.6 kN {7,200 kgf} for main winch and auxiliary winch.

Boom length	13.1m	17.4m				21.8m				26.2m			
Telescoping conditions (%)													
Tele.1	0	0	0	0	0	0	45	0	0	0	45	0	
Tele.2	0	0	45	0	0	0	45	45	0	0	45	45	
Tele.3	0	0	0	45	0	0	0	45	0	45	45	45	
Tele.4	0	0	0	0	0	45	0	0	45	45	0	45	
Tele.5	0	45	0	0	90	45	0	0	90	45	0	0	
Number of parts of line	22	6	14	14	6	6	12	12	6	6	10	9	

Boom length	30.6m				35.0m				39.4m			
Telescoping conditions (%)												
Tele.1	0	0	90	45	0	45	90	0	0	90	45	
Tele.2	0	45	45	45	0	45	45	45	0	45	45	
Tele.3	0	45	45	45	45	45	45	45	90	45	45	
Tele.4	90	45	0	45	90	45	45	45	90	45	45	
Tele.5	90	45	0	0	90	45	0	90	90	45	90	
Number of parts of line	6	6	8	8	6	6	7	6	4	6	6	

Boom length	43.8m				48.2m			52.6m	57.0m	61.0m	
Telescoping conditions (%)											
Tele.1	0	45	90	90	0	90	45	45	90	90	100
Tele.2	45	45	90	45	90	90	90	90	90	90	100
Tele.3	90	45	45	45	90	90	90	90	90	90	100
Tele.4	90	90	45	45	90	45	90	90	90	90	100
Tele.5	90	90	45	90	90	45	45	90	45	90	100
Number of parts of line	4	4	4	4	4	4	4	4	4	4	4

The lifting capacity data stored in the AUTOMATIC MOMENT LIMITER (AML) is based on the standard number of parts of line listed in the chart.

Maximum lifting capacity is restricted by the number of parts of line of AUTOMATIC MOMENT LIMITER (AML).

RATED LIFTING CAPACITIES

ISO 4305

WITHOUT COUNTERWEIGHT													
ON-RUBBER STATIONARY (Unit: x 1,000kg)													
A	Over front and rear						360° Rotation						
	13.1m		17.4m		21.8m		13.1m		17.4m		21.8m		
	C		C		C		C		C		C		C
B													
2.50	73	10.0	78	10.0	80	10.0	73	10.0	78	10.0	80	10.0	
3.00	71	10.0	76	10.0	79	10.0	71	10.0	76	10.0	79	10.0	
3.50	68	10.0	74	10.0	78	10.0	68	9.9	74	10.0	78	10.0	
4.00	66	10.0	72	10.0	76	10.0	66	8.0	72	9.7	76	10.0	
4.50	63	10.0	71	10.0	75	10.0	63	6.4	71	8.1	75	9.0	
5.00	61	9.2	69	10.0	74	10.0	61	5.1	69	6.8	74	7.7	
5.50	58	8.0	67	9.5	72	10.0	58	4.0	67	5.7	72	6.6	
6.00	55	6.9	65	8.4	71	9.1	55	3.0	65	4.7	71	5.6	
6.50	52	5.9	63	7.4	69	8.1	52	2.1	63	3.9	69	4.8	
7.00	49	5.1	61	6.5	68	7.4			61	3.1	68	4.1	
7.50	46	4.3	59	5.8	67	6.6			59	2.4	67	3.3	
8.00	43	3.3	57	5.1	65	5.9			57	1.7	65	2.7	
9.00	35	1.8	53	3.7	62	4.6					62	1.7	
10.00			49	2.4	59	3.4							
11.00			44	1.5	56	2.4							
12.00					52	1.7							
D	0		40		50		47		56		59		
Telescoping conditions (%)													
Tele.1	0		0		0		0		0		0		0
Tele.2	0		0		0		0		0		0		0
Tele.3	0		0		0		0		0		0		0
Tele.4	0		0		0		0		0		0		0
Tele.5	0		45		90		0		45		90		
E	4												

NOTE: The lifting capacity data stowed in the AUTOMATIC MOMENT LIMITER (AML) is based on the standard number of parts of line listed in the chart. Standard number of parts of line for on-rubber operation should be according to the chart.

- A** : Boom length (m)
- B** : Load radius (m)
- C** : Loaded boom angle (°)
- D** : Minimum boom angle (°)
for indicated length (no load)
- E** : Number of parts of line

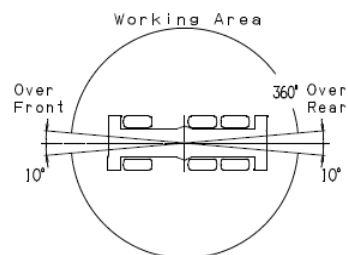

NOTES FOR "ON-RUBBER" TABLES

1. Rated lifting capacities shown in the table are based on condition that crane is set on firm level surface, with suspension lock applied. Those above thick lines are based on tire capacity and those below, on crane stability. They are based on actual load radius increased by tire deformation and boom deflection.
2. Rated lifting capacities based on crane stability are according to ISO4305.
3. The mass of the hook (1,080 kg for 100t capacity, 610 kg for 45t capacity, 300 kg for 7.2t capacity), slings and all similarly used load handling devices must be considered as part of the load and must be deducted from the lifting capacities.
4. For rated lifting capacity of single top, reduce the rated lifting capacities of relevant boom according to weight reductions for auxiliary load handling equipment. Capacities of single top shall not exceed 7,200 kg including main hook.
5. On-rubber lifting with "jib" is not permitted. Maximum permissible boom length is 21.8 m.
6. Tires should be inflated to their correct air pressure of 650kPa.
7. Standard number of parts of line for on-rubber operation should be according to the following table.

Load per line should not surpass 70.6 kN {7,200 kgf} for main winch and auxiliary winch.

Boom length	13.1m	17.4m	21.8m
Telescoping conditions (%)			
Tele.1	0	0	0
Tele.2	0	0	0
Tele.3	0	0	0
Tele.4	0	0	0
Tele.5	0	45	90
Number of parts of line	4	4	4

The lifting capacity data stowed in the AUTOMATIC MOMENT LIMITER (AML) is based on the standard number of parts of line listed in the chart.

Maximum lifting capacity is restricted by the number of parts of line of AUTOMATIC MOMENT LIMITER (AML).

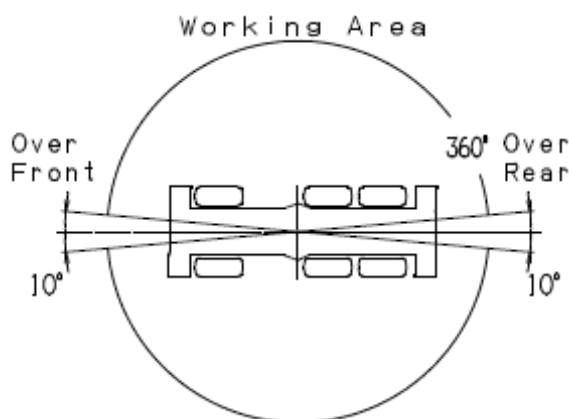

Over front and rear operation shall be performed within 10 degrees.

WORKING RANGE CHART

Manual offset jib
Counterweight 29.3t

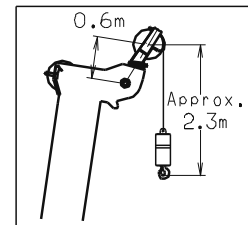
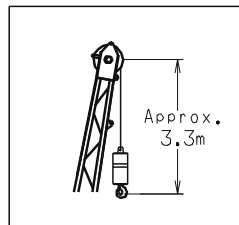
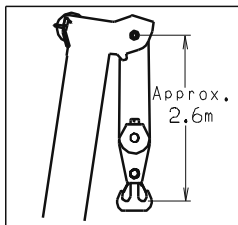
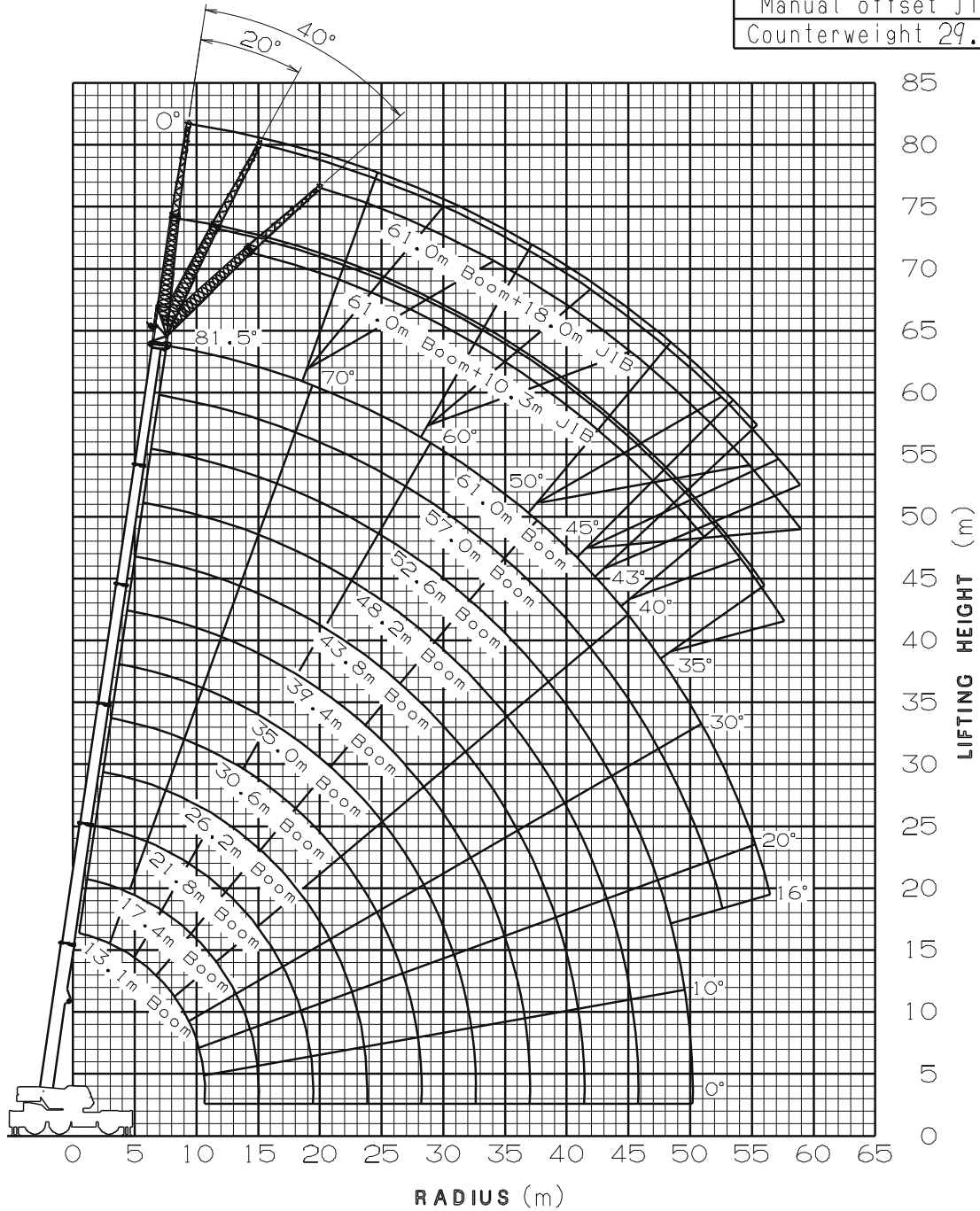

NOTE: 1. Boom and jib geometry shown are for unloaded condition and machine standing level on firm supporting surface.
 Boom deflection and subsequent radius and boom angle change must be accounted for when applying load to hook.

WORKING RANGE CHART

Manual offset jib
Counterweight 18.2t

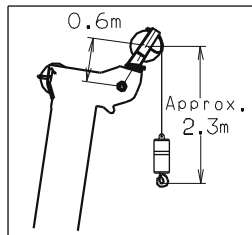
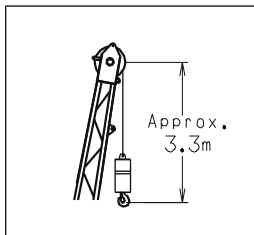
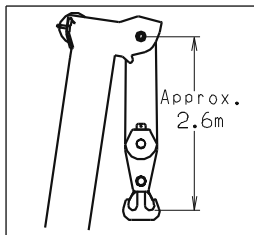
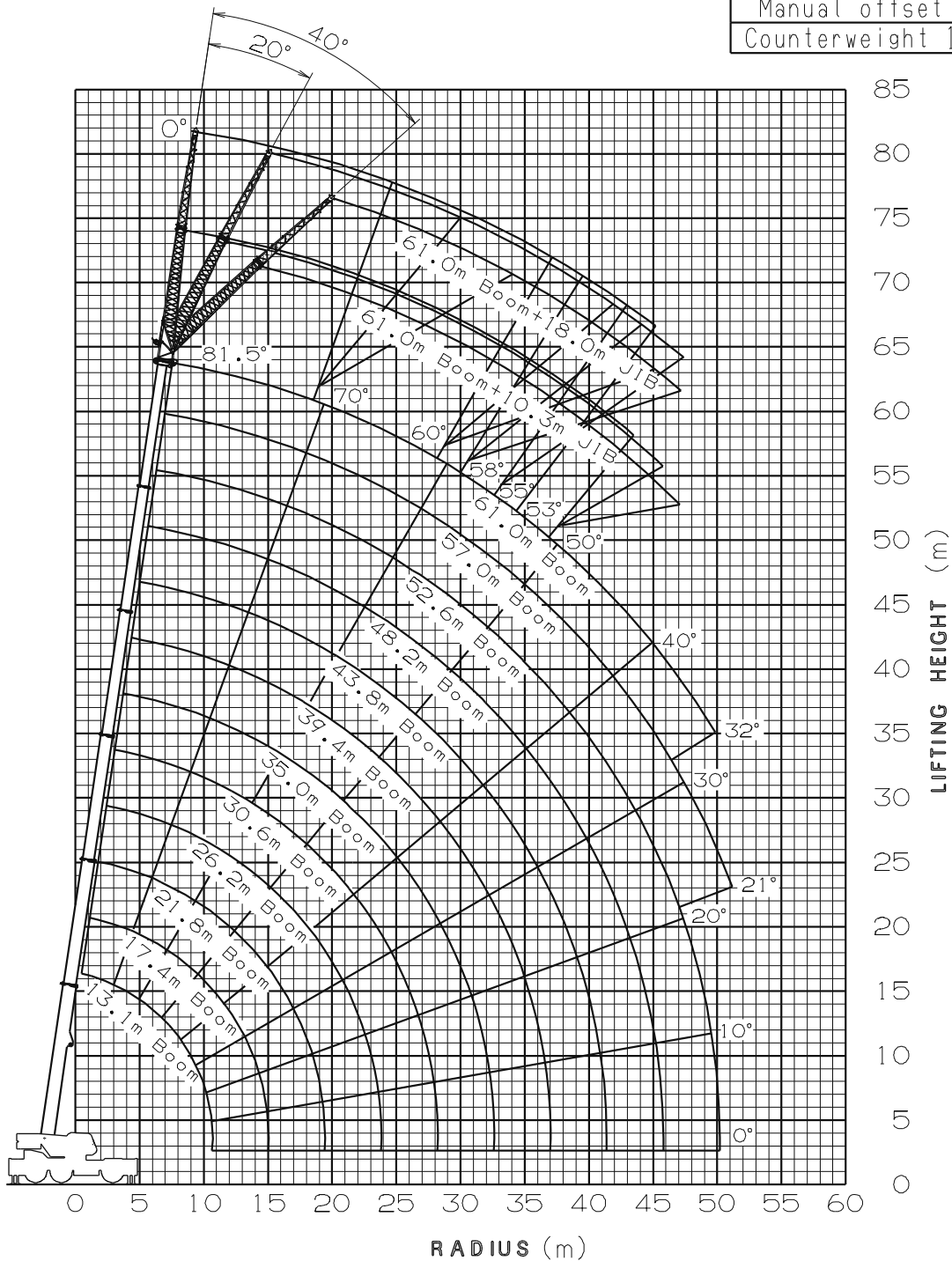

NOTE: 1. Boom and jib geometry shown are for unloaded condition and machine standing level on firm supporting surface.
 Boom deflection and subsequent radius and boom angle change must be accounted for when applying load to hook.

DIMENSIONS

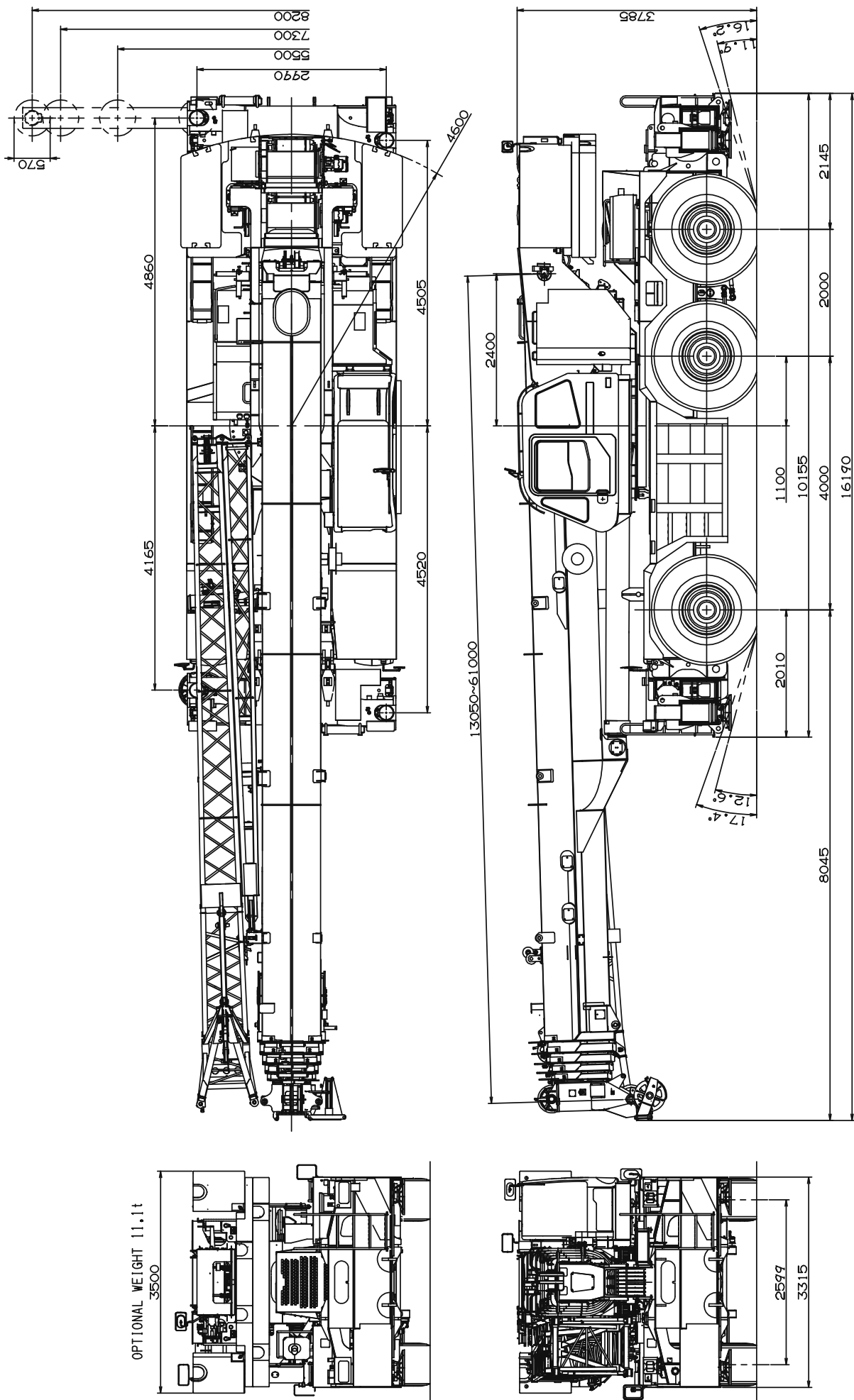

Note: Dimension is with boom angle at -1.5 degree.

GR-1450EX Axle Weight Distribution Chart

UNIT : kg

		Kilograms			
		GVW	1st	2nd	3rd
Base machine		90,805	28,701	30,814	31,290
Remove:	1.7.2 t hook block	-300	-421	61	61
	2.100t hook block	-1,080	-1,771	346	346
	3.Counterweight 11,100kg	-11,120	3,351	-7,236	-7,236
	4.Counterweight 18,200kg	-18,160	5,473	-11,816	-11,816
	5.Front outrigger unit	-4,481	-5,742	630	630
	6.Rear outrigger unit	-4,481	2,279	-3,380	-3,380
	7.Auxiliary Winch&wire rope	-1,202	490	-846	-846
	8.Top jib	-387	-460	37	37
	9.Base jib	-1,063	-1,838	388	388
	10.Boom	-15,624	-19,547	1,962	1,962
Add:	45t hook block	+610	+1,000	-195	-195