



GR-150XL

(Right-hand drive)

15 Ton (13.6 Metric Tons) Capacity

SPEC. SHEET NO. GR-150-2-00102/US-04

HYDRAULIC ROUGH TERRAIN CRANE

DIMENSIONS

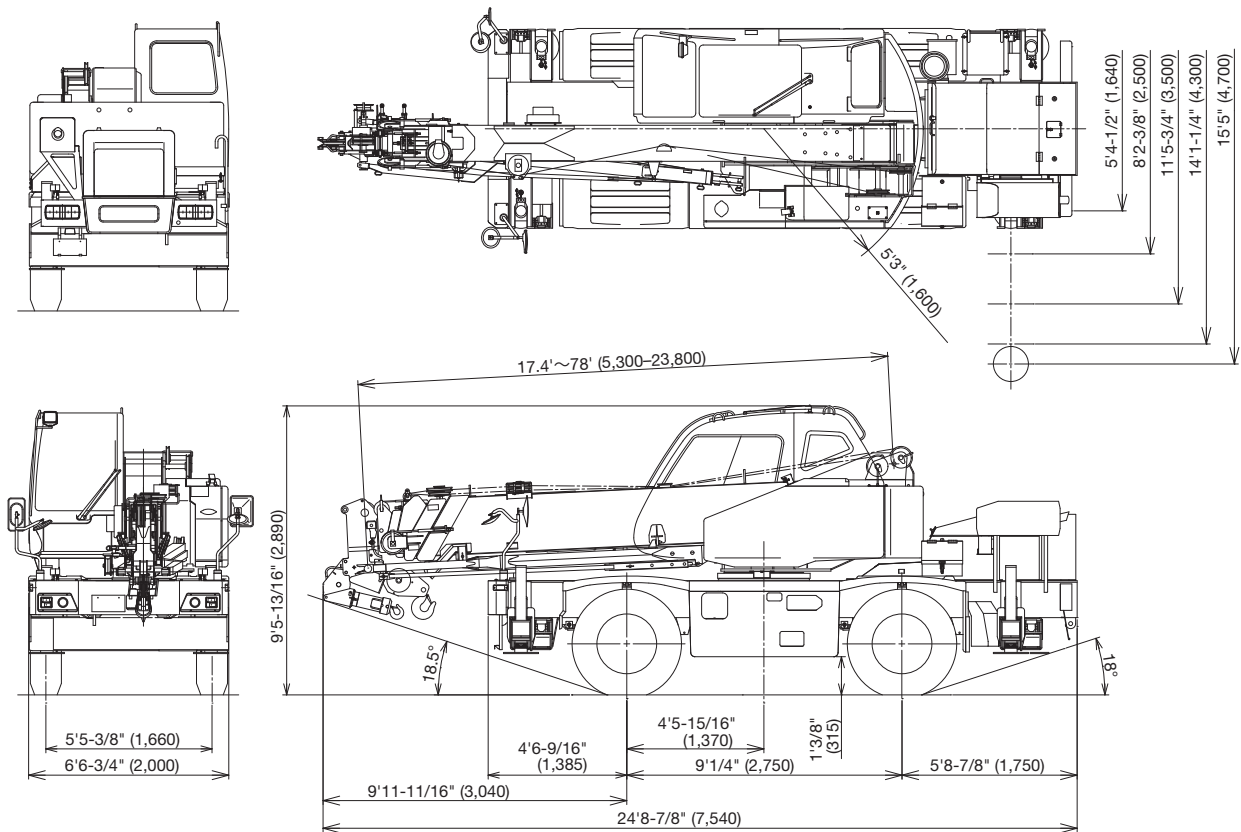

Note: In this external views, a few equipment are included.

GENERAL DIMENSIONS

	Feet	Meter
Turning radius (315/80R22.5 Tires)		
4 wheel steer	14' 5-1/4"	4.4
2 wheel steer	24' 11-1/8"	7.6

	Feet	Meter
Overall length	approx. 24' 8-7/8"	7,540
Overall width	approx. 6' 6-3/4"	2,000
Overall height	approx. 9' 5-13/16"	2,890

CRANE SPECIFICATIONS

BOOM

6 section full power partially synchronized telescoping boom of rectangular box construction with 4 sheaves at boom head. The synchronization system consists of 2 telescope cylinders, extension cables and retraction cables. Hydraulic cylinder fitted with holding valve. An easily removable wire rope guard, rope dead end provided on the left side of boom head. Boom telescope sections are supported by wear pads both vertically and horizontally.

Fully retracted length.....	17.4' (5.3 m)
Fully extended length	78' (23.8 m)
Extension speed.....	60.6' (18.5 m) in 52 s
Root diameter.....	8-14/16" (0.225 m)

BOOM ELEVATION

By a double acting hydraulic cylinder with holding valve. Combination controls for hand or foot operation. Boom angle indicator.

Automatic speed reduction and slow stop function.

Boom angle	-3°– 82°
Boom raising speed	-3° to 82° in 29 s

JIB

2 stage boom under slung type with quadruple offset (tilt type). Single sheave at jib head.

Box type top section telescopes from box type base section which stows under base boom section.

Length	11.8' (3.6 m), 18' (5.5 m)
Offset.....	5°, 25°, 45° or 60°
Root diameter.....	7-9/16" (0.192 m)

AUXILIARY LIFTING SHEAVE (SINGLE TOP)

Single sheave mounted to main boom head for single line work. Root diameter..... 7-9/16" (0.192 m)

ANTI-TWO-BLOCK DEVICE

Pendant type over-winding cut out device with audio-visual (FAILURE lamp/BUZZER) warning system.

SLEWING

Hydraulic axial piston motor driven through planetary slewing speed reducer. Continuous 360° full circle slewing on ball bearing.

Equipped with manually locked/released slewing brake. A 360° positive slewing lock for pick and carry and travel modes. Slewing speed..... 2.4 min⁻¹ {rpm}

WINCH

MAIN WINCH

Variable speed type with grooved drum driven by hydraulic axial piston motor through speed reducer. Power load lowering and raising. Equipped with automatic brake (neutral brake) and counterbalance valve. Controlled independently of auxiliary winch. Equipped with cable follower and drum rotation indicator.

MAIN DRUM

Root diameter x wide	10-7/16" (0.265 m) x 9-7/16" (0.239 m)
Wire rope diameter x length	7/16" (11.2 mm) x 450' (137 m)
Drum capacity	486.8' (148.4 m), 7 layers
Maximum single line pull (1st layer).....	6,700 lbs (3,050 kgf)
Maximum permissible line pull wire strength...	5,450 lbs (2,470 kgf)

AUXILIARY WINCH

Variable speed type with grooved drum driven by hydraulic axial piston motor through speed reducer. Power load lowering and raising. Equipped with automatic brake (neutral brake) and counterbalance valve. Controlled independently of main winch. Equipped with cable follower and drum rotation indicator.

AUXILIARY DRUM

Root diameter x wide	10-7/16" (0.265 m) x 9-7/16" (0.239 m)
Wire rope diameter x length	7/16" (11.2 mm) x 217' (66 m)
Drum capacity	486.8' (148.4 m), 7 layers
Maximum single line pull (1st layer).....	6,700 lbs (3,050 kgf)
Maximum permissible line pull wire strength...	5,730 lbs (2,600 kgf)

WIRE ROPE

Filler or warrington seal wire (spin-resistant), extra improved plow steel, preformed, independent wire rope core, right regular lay. Main..... 7/16" (11.2 mm) 6 x 37 class
Auxiliary..... 7/16" (11.2 mm) 6 x 37 class

HOOK BLOCKS

15.0 ton (13.6 metric ton)
4 sheaves with swivel hook and safety latch
2.0 ton (1.8 metric ton)
Weighted hook with swivel and safety latch

HYDRAULIC SYSTEM

PUMPS

2 variable piston pumps for crane functions. Tandem gear pump for steering, slewing and optional equipment. Powered by carrier engine. Pump disconnect for crane is engaged/disengaged by rotary switch from operator's cab.

CONTROL VALVES

Multiple valves actuated by pilot pressure with integral pressure relief valves.

RESERVOIR

45 gallon (172 lit.) capacity. External sight level gauge.

FILTRATION

BETA10=10 return filter, full flow with bypass protection, located inside of hydraulic reservoir. Accessible for easy replacement.

OIL COOLER - Air cooled fan type.

CAB AND CONTROLS

Both crane and drive operations can be performed from one cab mounted on rotating superstructure.

Right side, 1 man type, steel construction with sliding door access and safety glass windows opening at side. Door window is powered control. Windshield glass window and roof glass window are shatter-resistant. Wiper and washer (front windshield and roof window). Tinted safety glass and sun visor. Tilt-telescoping steering wheel. Adjustable control levers for slewing, boom elevating, boom telescoping, auxiliary winch and main winch. Control levers can change neutral positions and tilt for easy access to cab. Foot operated controls: boom elevating, boom telescoping, service brake and engine throttle. 3 way adjustable operator's suspension seat with high back, headrest and armrest. Cab floor mat. Engine throttle knob. Hot water cab heater and air conditioning.

Dash-mounted engine start/stop, monitor lamps, cigarette lighter, drive selector switch, parking brake switch, steering mode select switch, power window switch, pump engaged/disengaged switch, slewing brake switch, outrigger control panel.

Instruments - Torque converter oil temperature, engine water temperature, air pressure, fuel, speedometer, tachometer, hour meter and odometer / tripmeter. Engine over-run alarm. Back-up alarm. Low oil pressure/high water temp. Warning device (visual). Rear steer centering light. Hydraulic oil pressure is monitored and displayed on the AML-C display panel.

CRANE SPECIFICATIONS

TADANO electronic Load Moment Indicator system (AML-C) including:

- Control lever lockout function with audible and visual pre-warning
- Number of parts of line
- Boom position indicator
- Outrigger state indicator
- Slewing angle
- Boom angle / boom length / jib offset angle / jib length / load radius / rated lifting capacities / actual loads read out
- Potential lifting height
- Ratio of actual load moment to rated load moment indication
- Permissible load
- Automatic Speed Reduction and Slow Stop function on boom elevation and slewing
- Working condition register switch
- Load radius / boom angle / tip height / slewing range preset function
- External warning lamp
- Tare function

- Main hydraulic oil pressure
- Fuel consumption monitor
- Drum rotation indicator (audible and visible type) main and auxiliary winch
- On-rubber indicator

TADANO AML-C monitors outrigger extended length and automatically programs the corresponding "RATED LIFTING CAPACITIES" table

Operator's left hand console includes transmission gear selector and sight level bubble.

Upper left console includes, roof washer and wiper switch, jib equipped/removed select switch and air conditioning control switch.

Lower left console includes flood lamp switch, oil cooler switch and boom emergency telescoping switch (2nd-3rd and 4th-top)

NOTE: Each crane motion speed is based on unladen conditions.

CARRIER SPECIFICATIONS

TYPE

Rear engine, right-hand drive, driving axle 2-way selected type by manual switch, 4x2 front drive, 4x4 front and rear drive.

FRAME

High tensile steel, all welded mono-box construction.

ENGINE

Model	Mitsubishi 4M50-TLU3B [EUROMOT Stage IIIA] 4M50-TLA3B [EPA Tier3]
Type	Direct injection diesel
No. of cylinders	4
Combustion	4 cycle, turbo charged and after cooled
Bore x Stroke, in. (mm)	4.488 x 4.724 (114 x 120)
Displacement, cu. in. (liters)	299 (4.9)
Air inlet heater	24 volt preheat
Air cleaner	Dry type, replaceable element
Oil filter	Full flow with replaceable element
Fuel filter	Full flow with replaceable element
Fuel tank, gal. (liters)	50 (189), right side of carrier
Cooling	Liquid pressurized, recirculating by-pass
Radiator	Fin and tube core, thermostat controlled
Fan, in. (mm)	Suction type, 10-blade, 18 (457) dia.
Starting	24 volt
Charging	24 volt system, negative ground
Battery	2-80 amp. Hour
Compressor, air, CFM (l/min)	21.6 (612) at 2,700 min ⁻¹
Output, Max. HP (kW)	Gross 172 (129) at 2,700 min ⁻¹
Torque, Max. ft-lb (kgm)	390 (54) at 1,600 min ⁻¹
Capacity, gal. (liters)	
Cooling water	2.9 (11)
Lubrication	2.1-2.9 (8-11)
Fuel	50 (189)

TRANSMISSION

Electronically controlled full automatic transmission.
Torque converter driving full power shift with driving axle selector.
6 forward and 2 reverse speeds, constant mesh.
 2 speeds - high range - 2-wheel drive; 4-wheel drive
 3 speeds - low range - 4-wheel drive

TRAVEL SPEED - 25 mph (41 km/h)

GRADEABILITY (tanθ) - 49% (at stall), 30% *

* Machine should be operated within the limit of engine crankcase design (30°: Mitsubishi 4M50-TLU3B/TLA3B)

AXLE

Front: Full floating type, steering and driving axle with planetary reduction.

Rear: Full floating type, steering and driving axle with planetary reduction.

STEERING

Hydraulic power steering controlled by steering wheel.

4 steering modes available: 2 wheel front, 2 wheel rear, 4 wheel coordinated and 4 wheel crab.

SUSPENSION

Front: Semi-elliptic leaf springs with hydraulic lockout device.

Rear: Semi-elliptic leaf springs with hydraulic lockout device.

BRAKE SYSTEMS

Service: Air over hydraulic disc brakes on all 4 wheels.

Parking/Emergency: Spring applied-air released brake acting on input shaft of front axle.

Auxiliary: Electro-pneumatic operated exhaust brake.

TIRES - 315/80R22.5 (OR) Air pressure: 850 kPa

OUTRIGGERS

4 hydraulic, beam and jack outriggers.

Vertical jack cylinders equipped with integral holding valve.

Each outrigger beam and jack is controlled independently from cab.

Beams extend to 15'5" (4.7 m) center-line and retract to within

5'4-1/2" (1.64 m) overall width with floats. Outrigger jack floats

are attached thus eliminating the need of manually attaching and

detaching them. Controls and sight bubble located in

superstructure cab. 4 outrigger extension lengths are provided with

corresponding "RATED LIFTING CAPACITIES" for crane duty in

confined areas.

Min. Extension	5'4-1/2" (1.64 m) center to center
Mid. Extension	8'2-3/8" (2.5 m) center to center
Mid. Extension	11'5-3/4" (3.5 m) center to center
Mid. Extension	14'1-1/4" (4.3 m) center to center
Max. Extension	15'5" (4.7 m) center to center
Float size (Diameter)	1'1-3/4" (0.35 m)

STANDARD EQUIPMENT

- Telematics (machine data logging and monitoring system) with - HELLO-NET via internet (availability depends on countries)
- Eco mode system
- Emergency steering system
- Transmission neutral position engine start
- Overshift prevention
- Parking braked travel warning
- Tilt-telescope steering wheel
- Halogen head lamp
- Fenders
- Air dryer
- Water separator with filter (high filtration)
- Air cleaner dust indicator
- Full instrumentation package
- Towing hooks-Front and rear
- Tool storage compartment
- External warning lamp
- Tire inflation kit

HOISTING PERFORMANCE

LINE SPEEDS AND PULLS

Layer	Main or auxiliary winch - 10-7/8" (0.28 m) drum			
	Line speeds ¹		Line pulls Available ²	
	F.P.M	m/min	Lbs.	kgf
1st	308	94	6,700	3,050
2nd	330	101	6,200	2,810
3rd	361	110	5,700	2,610
4th	375	114	5,400	2,430
5th	410	125	5,000	2,280
6th	420	128	4,700	2,140
7th ³	443	135	4,500	2,020

- Maximum permissible line pull wire strength.
Main: 5,450 lbs (2,470 kgf) with 6x37 class rope.
Auxiliary: 5,730 lbs kN (2,600 kgf) with 6x37 class rope.

¹ Line speed based only on hook block, not loaded.
² Developed by machinery with each layer of wire rope, but not based on rope strength or other limitations in machinery or equipment.
³ Seventh layer of wire rope are not recommended for hoisting operations.

DRUM WIRE ROPE CAPACITIES

Wire rope layer	Main or auxiliary drum grooved lagging			
	7/16" (11.2 mm) wire rope			
	Rope per layer		Total wire rope	
	Feet	m	Feet	m
1	57.0	17.4	57.0	17.4
2	61.3	18.6	118.3	36.0
3	65.3	20.0	183.6	56.0
4	69.6	21.2	253.2	77.2
5	73.7	22.4	326.9	99.6
6	77.9	23.8	404.8	123.4
7	82.0	25.0	486.8	148.4

DRUM DIMENSIONS

	inch	mm
Root diameter	10-7/16	265
Length	Main	9-7/16
	Auxiliary	9-7/16
Flange diameter	17-23/32	450

GR-150XL WORKING RANGE CHART

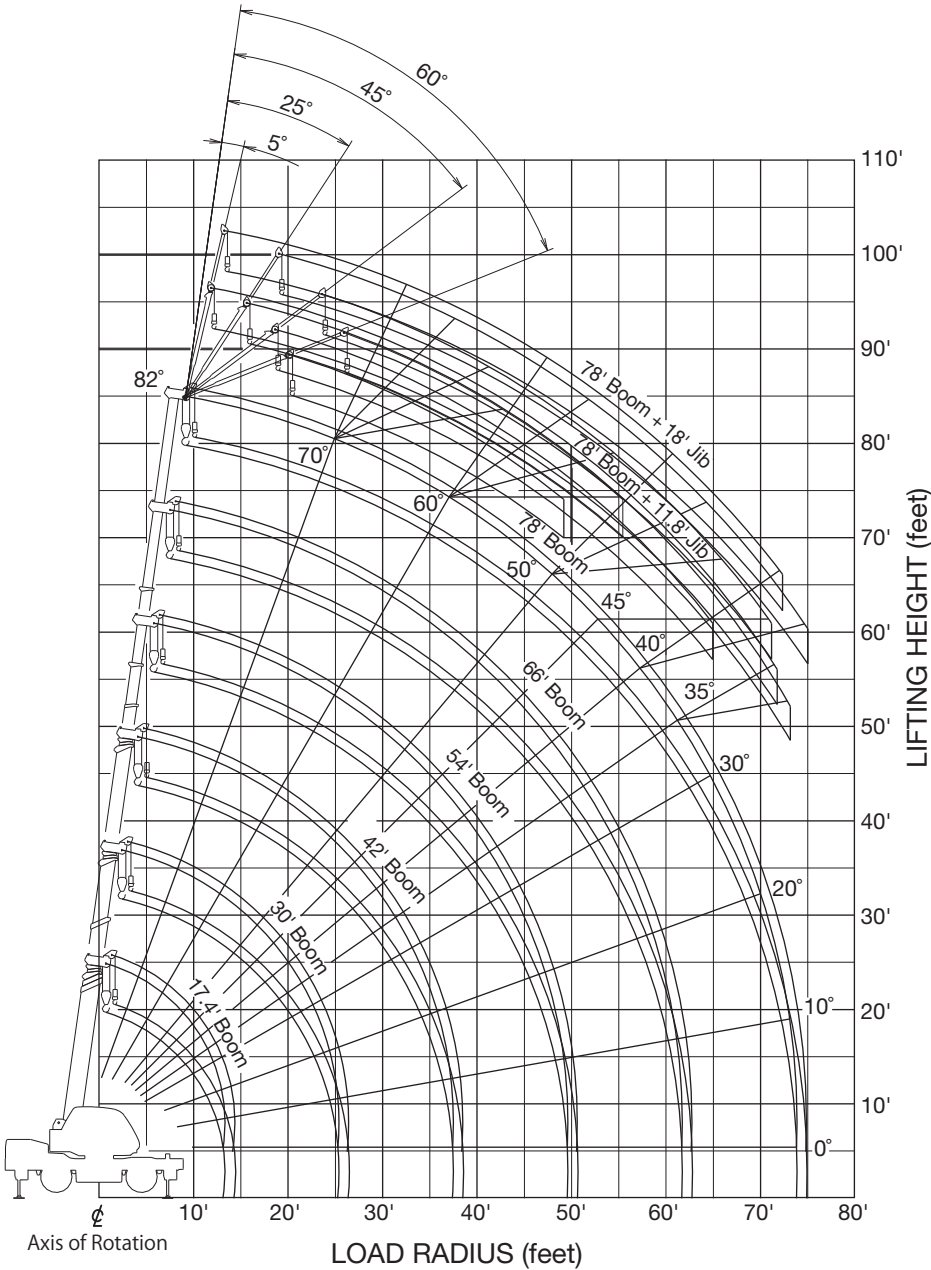

BOOM

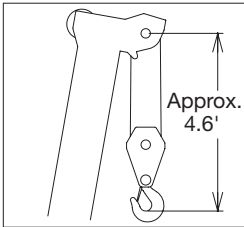

JIB

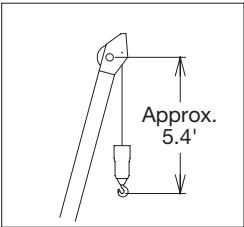

SINGLE TOP

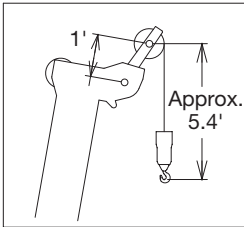

Boom Length

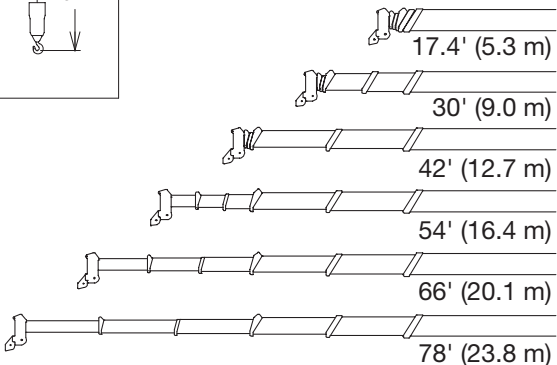

The above lifting height and boom angle are based on a straight (unloaded) boom and machine standing level on firm supporting surface. Allowance should be made for boom deflection obtained under loaded conditions. The above working range is shown on condition with outriggers fully (15'5") extended.

GR-150XL RATED LIFTING CAPACITIES (IN POUNDS)

ON OUTRIGGERS FULLY EXTENDED 15' 5" (4.7 m) SPREAD 360° ROTATION												
B	17.4'		30'		42'		54'		66'		78'	
	C	(5.3 m)	C	(9.0 m)	C	(12.7 m)	C	(16.4 m)	C	(20.1 m)	C	(23.8 m)
4	70.4	30,000	78.9	13,200								
5	66.7	30,000	77.3	13,200	80.9	13,200						
6	62.8	28,800	75.1	13,200	79.5	13,200						
8	54.2	23,800	70.8	13,200	76.7	13,200	79.9	11,000				
10	44.1	17,800	66.7	13,200	73.8	13,200	78.0	11,000	80.4	9,900		
12	30.8	14,800	62.4	13,200	71.0	13,200	75.8	11,000	78.7	9,900	80.5	6,600
15			55.4	11,500	66.6	11,100	72.4	10,850	76.0	8,950	78.5	6,600
20			42.1	8,300	58.5	8,000	66.6	7,750	71.5	7,050	74.8	6,050
25			19.5	6,200	49.8	5,850	60.6	5,700	66.8	5,500	70.9	4,950
30					39.4	4,050	54.3	4,400	61.8	4,400	66.9	4,100
35					25.2	2,950	47.1	3,350	56.5	3,550	62.6	3,350
40							38.9	2,650	51.0	3,150	58.3	2,800
45							28.3	1,950	44.8	2,400	53.7	2,350
50									37.9	1,850	48.6	2,000
55									29.3	1,400	43.2	1,550
60									16.2	1,050	37.2	1,250
65											29.9	1,000
70											20.2	770
D												0°

LIFTING CAPACITIES AT ZERO DEGREE BOOM ANGLE ON OUTRIGGERS FULLY EXTENDED 15' 5" (4.7 m) SPREAD 360° ROTATION												
C	17.4'		30'		42'		54'		66'		78'	
	B	(5.3 m)	B	(9.0 m)	B	(12.7 m)	B	(16.4 m)	B	(20.1 m)	B	(23.8 m)
0°	13.1	13,500	25.3	5,900	37.4	2,600	49.5	1,600	61.7	1,000	73.8	600

ON OUTRIGGERS MID EXTENDED 14' 1-1/4" (4.3 m) SPREAD OVER SIDE													
B	17.4'		30'		42'		54'		66'		78'		
	C	(5.3 m)	C	(9.0 m)	C	(12.7 m)	C	(16.4 m)	C	(20.1 m)	C	(23.8 m)	
4	70.4	30,000	78.9	13,200									
5	66.7	30,000	77.3	13,200	80.9	13,200							
6	62.8	28,800	75.1	13,200	79.5	13,200							
8	54.2	23,800	70.8	13,200	76.7	13,200	79.9	11,000					
10	44.1	17,800	66.7	13,200	73.8	13,200	78.0	11,000	80.4	9,900			
12	30.8	14,800	62.4	13,200	71.0	13,200	75.8	11,000	78.7	9,900	80.5	6,600	
15			55.3	11,300	66.6	11,100	72.4	10,850	76.0	8,950	78.5	6,600	
20			42.1	8,050	58.5	7,450	66.6	7,750	71.5	7,050	74.8	6,050	
25			19.5	5,500	49.8	5,300	60.6	5,400	66.7	5,100	70.9	4,950	
30					39.4	3,500	54.2	4,050	61.7	4,100	66.8	3,900	
35					25.2	2,500	47.0	2,850	56.5	3,200	62.6	3,200	
40							38.7	2,100	50.9	2,300	58.3	2,550	
45							28.1	1,450	44.6	1,750	53.6	1,950	
50									37.7	1,250	48.5	1,500	
55									29.3	900	43.1	1,150	
60									16.2	600	37.0	900	
65											29.8	600	
D												0°	23

LIFTING CAPACITIES AT ZERO DEGREE BOOM ANGLE ON OUTRIGGERS MID EXTENDED 14' 1-1/4" (4.3 m) SPREAD 360° ROTATION												
C	17.4'		30'		42'		54'		66'			
	B	(5.3 m)	B	(9.0 m)	B	(12.7 m)	B	(16.4 m)	B	(20.1 m)		
0°	13.1	13,200	25.3	5,200	37.4	2,000	49.5	1,100	61.7	500		

- A: Boom length in feet
- B: Load radius in feet
- C: Loaded boom angle (°)
- D: Minimum boom angle (°) for indicated boom length (no load)

GR-150XL RATED LIFTING CAPACITIES (IN POUNDS)

ON OUTRIGGERS MID EXTENDED 11' 5-3/4" (3.5 m) SPREAD OVER SIDE												
B \ A	17.4'		30'		42'		54'		66'		78'	
	C	(5.3 m)	C	(9.0 m)	C	(12.7 m)	C	(16.4 m)	C	(20.1 m)	C	(23.8 m)
4	70.4	30,000	78.9	13,200								
5	66.7	30,000	77.3	13,200	80.9	13,200						
6	62.8	28,800	75.1	13,200	79.5	13,200						
8	54.2	23,800	70.8	13,200	76.7	13,200	79.9	11,000				
10	44.1	17,800	66.7	13,200	73.8	13,200	78.0	11,000	80.4	9,900		
12	30.8	14,800	62.4	13,200	71.0	13,200	75.8	11,000	78.7	9,900	80.5	6,600
15			55.2	10,150	66.6	10,000	72.4	9,450	76.0	8,950	78.5	6,600
20			42.0	5,800	58.5	5,550	66.5	6,300	71.4	6,550	74.8	5,950
25			19.5	3,600	49.7	3,400	60.4	4,050	66.6	4,400	70.8	4,500
30					39.3	2,100	53.9	2,650	61.4	3,000	66.7	3,100
35					24.9	1,250	46.5	1,800	56.3	2,050	62.4	2,250
40							38.3	1,150	50.6	1,350	58.0	1,550
45							27.6	700	44.5	950	53.2	1,050
50									37.4	650	48.2	700
55											42.9	450
D	0°						26°			39°		

LIFTING CAPACITIES AT ZERO DEGREE BOOM ANGLE ON OUTRIGGERS MID EXTENDED 11' 5-3/4" (3.5 m) SPREAD OVER SIDE								
C \ A	17.4'		30'		42'		54'	
	B	(5.3 m)	B	(9.0 m)	B	(12.7 m)	B	(16.4 m)
0°	13.1	13,200	25.3	3,300	37.4	1,000	49.5	400

ON OUTRIGGERS MID EXTENDED 8' 2-3/8" (2.5 m) SPREAD OVER SIDE												
B \ A	17.4'		30'		42'		54'		66'		78'	
	C	(5.3 m)	C	(9.0 m)	C	(12.7 m)	C	(16.4 m)	C	(20.1 m)	C	(23.8 m)
4	70.4	30,000	78.9	13,200								
5	66.7	30,000	77.3	13,200	80.9	13,200						
6	62.8	28,800	75.1	13,200	79.5	13,200						
8	54.1	18,700	70.8	13,200	76.7	13,200	79.9	11,000				
10	43.6	12,200	66.7	11,800	73.7	11,800	78.0	11,000	80.4	9,900		
12	30.5	8,800	62.3	8,600	70.8	8,550	75.6	9,250	78.7	9,900	80.5	6,600
15			55.2	5,450	66.3	5,350	72.2	6,000	75.8	6,300	78.5	6,600
20			42.0	2,850	58.3	2,750	66.4	3,300	71.1	3,600	74.5	3,850
25			19.5	1,500	49.6	1,350	60.3	1,900	66.3	2,200	70.4	2,350
30					39.0	500	53.8	1,000	61.3	1,350	66.3	1,450
35							46.5	500	56.0	750	62.0	850
40											57.7	450
D	0°				30°		41°		49°		55°	

LIFTING CAPACITIES AT ZERO DEGREE BOOM ANGLE ON OUTRIGGERS MID EXTENDED 8' 2-3/8" (2.5 m) SPREAD OVER SIDE				
C \ A	17.4'		30'	
	B	(5.3 m)	B	(9.0 m)
0°	13.1	7,400	25.3	1,300

- A: Boom length in feet
- B: Load radius in feet
- C: Loaded boom angle (°)
- D: Minimum boom angle (°) for indicated boom length (no load)

GR-150XL RATED LIFTING CAPACITIES (IN POUNDS)

ON OUTRIGGERS MIN EXTENDED 5' 4-1/2'' (1.64 m) SPREAD OVER SIDE												
A	17.4'		30'		42'		54'		66'		78'	
	C	(5.3 m)	C	(9.0 m)	C	(12.7 m)	C	(16.4 m)	C	(20.1 m)	C	(23.8 m)
4	70.3	17,500	78.9	13,200								
5	66.6	15,300	77.4	12,800	80.9	12,500						
6	62.5	13,250	75.0	12,300	79.5	12,500						
8	54.1	8,650	70.8	8,800	76.6	8,300	79.9	7,500				
10	44.0	5,800	66.6	6,100	73.8	5,600	77.6	5,600	80.1	5,600		
12	30.1	4,250	62.2	4,100	70.9	4,050	75.3	4,200	78.3	4,300	80.4	4,350
15			55.2	2,450	66.4	2,300	72.0	2,700	75.5	3,000	77.9	3,100
20			41.8	900	58.5	750	66.2	1,250	71.0	1,550	74.1	1,800
25											70.2	950
D	0°		26°		52°		58°		63°		67°	

LIFTING CAPACITIES AT ZERO DEGREE BOOM ANGLE ON OUTRIGGERS MIN EXTENDED 5' 4-1/2'' (1.64 m) SPREAD OVER SIDE											
A	17.4'										
	C	B	(5.3 m)								
0°	13.1	3,500									

- A: Boom length in feet
- B: Load radius in feet
- C: Loaded boom angle (°)
- D: Minimum boom angle (°) for indicated boom length (no load)

Note:
 Standard number of parts of line for each boom length is as shown below.
 Load per line should not surpass 4,000 lbs (1,800 kg) for main winch and auxiliary winch.

Boom Length in feet (meters)	17.4' (5.3 m)	17.4' to 78' (5.3 m to 23.8 m)	Single top Jib
Number of parts of line	8	4	1

The lifting capacity data stored in the Load Moment Indicator (AML-C) is based on the standard number of parts of line listed in the chart.

GR-150XL RATED LIFTING CAPACITIES (IN POUNDS)

ON OUTRIGGERS FULLY EXTENDED 15' 5" (4.7 m) SPREAD 360° ROTATION									
C	78' (23.8 m) Boom + 11.8' (3.6 m) Jib								
	5° Tilt		25° Tilt		45° Tilt		60° Tilt		
	R	W	R	W	R	W	R	W	
82°	12.6	3,300	16.7	2,650	19.6	2,000	21.5	1,400	
80°	16.1	3,300	20.0	2,650	22.7	2,000	24.6	1,400	
77.5°	20.4	3,300	24.2	2,650	26.5	2,000	28.1	1,400	
75°	24.4	3,300	28.1	2,650	30.3	2,000	31.9	1,400	
72.5°	28.3	3,000	31.8	2,400	33.9	1,900	35.3	1,400	
70°	32.1	2,750	35.4	2,200	37.4	1,850	38.9	1,400	
67.5°	35.7	2,500	38.9	2,100	40.8	1,800	41.9	1,400	
65°	39.2	2,300	42.3	1,950	44.2	1,700	45.3	1,400	
62.5°	42.8	2,100	45.7	1,850	47.3	1,600	48.1	1,400	
60°	46.1	1,950	49.0	1,750	50.3	1,550	51.1	1,400	
57.5°	49.1	1,750	51.9	1,600	53.3	1,500			
55°	52.1	1,550	54.9	1,400	56.0	1,400			
52.5°	55.1	1,300	57.7	1,200	58.6	1,200			
50°	57.9	1,100	60.3	1,000	61.2	1,050			
47.5°	60.7	950	62.8	900	63.6	900			
45°	63.2	800	65.3	750	65.8	750			
42.5°	65.7	700	67.6	600					
40°	68.1	550	69.9	500					
37.5°	70.4	450	72.0	400					
35°	72.5	350	73.9	350					

78' (23.8 m) Boom + 18' (5.5 m) Jib									
C	5° Tilt		25° Tilt		45° Tilt		60° Tilt		
	R	W	R	W	R	W	R	W	
	82°	13.9	1,850	20.0	1,550	24.7	1,300	27.2	850
80°	17.5	1,850	23.5	1,550	28.0	1,300	30.1	850	
77.5°	21.9	1,850	27.9	1,550	31.9	1,200	33.9	850	
75°	26.3	1,850	32.1	1,550	35.8	1,200	37.4	850	
72.5°	30.6	1,850	36.0	1,500	39.6	1,200	41.2	850	
70°	34.7	1,850	39.7	1,400	43.1	1,150	44.5	850	
67.5°	38.6	1,800	43.3	1,350	46.5	1,100	47.9	850	
65°	42.5	1,750	47.1	1,300	49.8	1,100	50.9	850	
62.5°	46.1	1,600	50.5	1,250	53.0	1,100	54.0	850	
60°	49.6	1,450	53.8	1,200	56.1	1,050	56.8	850	
57.5°	53.1	1,350	57.2	1,150	59.1	1,000			
55°	56.4	1,250	60.3	1,100	61.9	1,000			
52.5°	59.5	1,100	63.3	1,000	64.7	950			
50°	62.7	1,000	66.0	900	67.4	900			
47.5°	65.4	850	68.7	800	69.8	800			
45°	68.1	700	71.2	650	72.0	650			
42.5°	70.8	600	73.7	550					
40°	73.4	500	76.0	450					

ON OUTRIGGERS MID EXTENDED 14' 1-1/4" (4.3 m) SPREAD OVER SIDE									
C	78' (23.8 m) Boom + 11.8' (3.6 m) Jib								
	5° Tilt		25° Tilt		45° Tilt		60° Tilt		
	R	W	R	W	R	W	R	W	
82°	12.6	3,300	16.7	2,650	19.6	2,000	21.5	1,400	
80°	16.1	3,300	20.0	2,650	22.7	2,000	24.6	1,400	
77.5°	20.4	3,300	24.2	2,650	26.5	2,000	28.1	1,400	
75°	24.4	3,300	28.1	2,650	30.3	2,000	31.9	1,400	
72.5°	28.3	3,000	31.8	2,400	33.9	1,900	35.3	1,400	
70°	32.1	2,750	35.4	2,200	37.4	1,850	38.9	1,400	
67.5°	35.7	2,500	38.9	2,100	40.8	1,800	41.9	1,400	
65°	39.2	2,300	42.3	1,950	44.2	1,700	45.3	1,400	
62.5°	42.6	2,000	45.7	1,800	47.3	1,550	48.1	1,400	
60°	45.8	1,750	48.9	1,600	50.3	1,400	51.1	1,400	
57.5°	48.9	1,500	51.8	1,400	53.1	1,250			
55°	51.9	1,200	54.7	1,150	55.8	1,100			
52.5°	54.8	1,000	57.3	950	58.4	900			
50°	57.7	800	60.1	750	61.0	750			
47.5°	60.4	650	62.6	600	63.4	600			
45°	63.0	500	65.1	500	65.7	500			

78' (23.8 m) Boom + 18' (5.5 m) Jib									
C	50° Tilt		25° Tilt		45° Tilt		60° Tilt		
	R	W	R	W	R	W	R	W	
	82°	13.9	1,850	20.0	1,550	24.7	1,300	27.2	850
80°	17.5	1,850	23.5	1,550	28.0	1,300	30.1	850	
77.5°	21.9	1,850	27.9	1,550	31.9	1,200	33.9	850	
75°	26.3	1,850	32.1	1,550	35.8	1,200	37.4	850	
72.5°	30.6	1,850	36.0	1,500	39.6	1,200	41.2	850	
70°	34.7	1,850	39.7	1,400	43.1	1,150	44.5	850	
67.5°	38.6	1,800	43.3	1,350	46.5	1,150	47.9	850	
65°	42.5	1,750	47.1	1,300	49.8	1,100	50.9	850	
62.5°	46.1	1,600	50.5	1,250	53.0	1,100	54.0	850	
60°	49.6	1,450	53.8	1,200	56.1	1,050	56.8	850	
57.5°	52.9	1,300	57.2	1,100	59.1	950			
55°	56.1	1,100	60.2	1,000	61.9	850			
52.5°	59.3	900	63.0	850	64.6	800			
50°	62.3	750	65.9	700	67.2	700			
47.5°	65.2	600	68.6	600	69.7	600			
45°	68.0	500	71.1	450	71.9	450			

C: Loaded boom angle (°)
R: Load radius in feet
W: Rated lifting capacity in pounds

GR-150XL RATED LIFTING CAPACITIES (IN POUNDS)

ON OUTRIGGERS MID EXTENDED 11' 5-3 / 4" (3.5 m) SPREAD OVER SIDE																	
C	78' (23.8 m) Boom + 11.8' (3.6 m) Jib								C	78' (23.8 m) Boom + 18' (5.5 m) Jib							
	5° Tilt		25° Tilt		45° Tilt		60° Tilt			5° Tilt		25° Tilt		45° Tilt		60° Tilt	
	R	W	R	W	R	W	R	W		R	W	R	W	R	W	R	W
82°	12.6	3,300	16.7	2,650	19.6	2,000	21.5	1,400	82°	13.9	1,850	20.0	1,550	24.7	1,300	27.2	850
80°	16.1	3,300	20.0	2,650	22.7	2,000	24.6	1,400	80.5°	17.5	1,850	23.5	1,550	28.0	1,300	30.1	850
77.5°	20.4	3,300	24.2	2,650	26.5	2,000	28.1	1,400	77.5°	21.9	1,850	27.9	1,550	31.9	1,200	33.9	850
75°	24.4	3,300	28.1	2,650	30.3	2,000	31.9	1,400	75°	26.3	1,850	32.1	1,550	35.8	1,200	37.4	850
72.5°	28.3	2,850	31.8	2,400	33.9	1,900	35.3	1,400	72.5°	30.6	1,850	36.0	1,500	39.6	1,200	41.2	850
70°	31.8	2,400	35.4	2,200	37.4	1,850	38.9	1,400	70°	34.7	1,850	39.7	1,400	43.1	1,150	44.5	850
67.5°	35.3	2,000	38.7	1,850	40.8	1,600	41.9	1,400	67.5°	38.6	1,650	43.3	1,300	46.5	1,100	47.9	850
65°	38.7	1,550	41.9	1,500	43.8	1,400	45.3	1,400	65°	42.2	1,450	46.9	1,150	49.8	1,000	50.9	850
62.5°	42.0	1,200	45.7	1,200	46.9	1,150	47.9	1,150	62.5°	45.7	1,200	50.2	1,000	52.9	850	53.8	750
60°	45.2	900	48.9	950	49.8	900	50.7	900	60°	48.9	900	53.4	800	55.8	700	56.6	650
57.5°	48.3	700	51.8	750	52.6	700			57.5°	52.2	700	56.7	600	58.7	600		
55°	51.4	550	54.2	550	55.4	500			55°	55.6	500	59.7	450	61.6	450		

ON OUTRIGGERS MID EXTENDED 8' 2-3 / 8" (2.5 m) SPREAD OVER SIDE																	
C	78' (23.8 m) Boom + 11.8' (3.6 m) Jib								C	78' (23.8 m) Boom + 18' (5.5 m) Jib							
	5° Tilt		25° Tilt		45° Tilt		60° Tilt			5° Tilt		25° Tilt		45° Tilt		60° Tilt	
	R	W	R	W	R	W	R	W		R	W	R	W	R	W	R	W
82°	12.6	3,300	16.7	2,650	19.6	2,000	21.5	1,400	82°	13.9	1,850	20.0	1,550	24.7	1,300	27.2	850
80°	16.1	3,200	20.0	2,650	22.7	2,000	24.6	1,400	80°	17.5	1,850	23.5	1,550	28.0	1,300	30.1	850
77.5°	20.1	2,850	23.9	2,300	26.3	1,900	28.1	1,400	77.5°	21.9	1,850	27.7	1,500	31.9	1,200	33.9	850
75°	23.9	2,400	27.7	2,000	30.0	1,750	31.9	1,400	75°	26.3	1,850	31.9	1,400	35.7	1,100	37.4	850
72.5°	27.5	1,800	31.1	1,550	33.5	1,400	35.1	1,150	72.5°	30.2	1,500	35.5	1,100	39.1	900	41.1	750
70°	31.0	1,250	34.5	1,100	36.7	1,000	38.3	850	70°	33.9	1,100	39.3	850	42.8	750	44.4	650
67.5°	34.5	900	37.9	800	39.9	700	41.4	570	67.5°	37.6	800						
65°	37.8	550	41.1	500	43.0	450	44.3	300	65°	41.0	450						

C: Boom angle (°)

R: Load radius in feet

W :Rated lifting capacity in pounds

GR-150XL RATED LIFTING CAPACITIES (IN POUNDS)

ON RUBBER STATIONARY												
A	Over Front						360° Rotation					
	17.4'		30'		42'		17.4'		30'		42'	
	C	(5.3 m)	C	(9.0 m)	C	(12.7 m)	C	(5.3 m)	C	(9.0 m)	C	(12.7 m)
4	70.3	7,900	79.0	7,900			70.3	6,200	79.0	6,200		
6	62.7	7,650	74.9	7,650	79.4	7,900	62.7	6,200	74.9	6,200	79.4	6,150
8	54.4	6,900	70.8	6,900	76.6	6,900	54.4	4,900	70.8	4,800	76.6	4,700
10	44.4	5,750	66.5	5,650	73.6	5,500	44.4	3,450	66.5	3,350	73.6	3,200
12	30.7	4,850	62.2	4,600	70.7	4,350	30.7	2,500	62.2	2,350	70.7	2,100
15			55.2	3,450	66.2	3,000			55.2	1,000	66.2	750
20			41.7	1,900	58.3	1,700						
25			19.2	550	49.4	650						
D	0°			42°			0°		44°		60°	

LIFTING CAPACITIES AT ZERO DEGREE BOOM ANGLE ON RUBBER STATIONARY												
A	Over Front						360° Rotation					
	17.4'		30'				17.4'					
	B	(5.3 m)	B	(9.0 m)			B	(5.3 m)				
0°	13.1	4,200	25.3	500			13.1	1,600				

ON RUBBER CREEP												
A	Over Front											
	17.4'		30'		42'							
	C	(5.3 m)	C	(9.0 m)	C	(12.7 m)						
4	70.3	7,050	79.0	7,050								
6	62.7	6,750	74.9	6,750	79.4	7,050						
8	54.4	6,200	70.8	6,100	76.6	5,900						
10	44.4	5,200	66.5	4,950	73.6	4,750						
12	30.7	4,150	62.2	4,000	70.7	3,750						
15			55.2	3,000	66.2	2,700						
20			41.7	1,700	58.3	1,500						
25			19.2	500	49.4	650						
D	0°			42°								

LIFTING CAPACITIES AT ZERO DEGREE BOOM ANGLE ON RUBBER CREEP												
A	Over Front											
	17.4'		30'									
	B	(5.3 m)	B	(9.0 m)								
0°	13.1	3,600	25.3	400								

- A: Boom length in feet
- B: Load radius in feet
- C: Loaded boom angle (°)
- D: Minimum boom angle (°) for indicated boom length (no load)

Note:
 The lifting capacity data stored in the Load Moment Indicator (AML-C) is based on the standard number of parts of line listed in the chart. Standard number of parts of line for on rubber operation should be according to the following table.

Boom Length in feet (meters)	17.4' to 42' (5.3 m to 12.7 m)	Single top
Number of parts of line	4	1

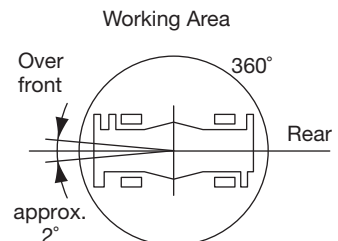

WARNING AND OPERATING INSTRUCTIONS FOR ON RUBBER LIFTING CAPACITIES

- Rated lifting capacities on-rubber are in pounds and do not exceed 75% of tipping loads as determined by SAE J765-Crane Stability Test Code.
- Rated lifting capacities shown in the chart are based on the condition that crane is set on firm level surfaces with suspension lock applied. Those above thick lines are based on tire capacity and those below, on crane stability. They are based on actual load radius increased by tire deformation and boom deflection.
- If the suspension lock cylinders contain air, the axle will not be locked completely and rated lifting capacities may not be obtainable. Bleed the cylinders according to the operation safety and maintenance manual.
- Rated lifting capacities are based on proper tire inflation, capacity and condition. Damaged tires are hazardous to safe operation of crane.
- Tires shall be inflated to correct air pressure.

Tires	Air Pressure
315/80R22.5	123 psi (8.5 kgf/cm ²)

- Over front operation shall be performed within 2 degrees in front of chassis.

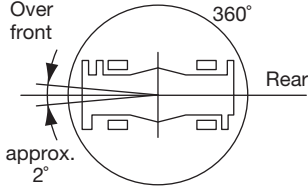

- On rubber lifting with "jib" is not permitted. Maximum permissible boom length is 42' (12.7 m).

- When making lift on rubber stationary, set parking brake.
- For creep operation, boom must be centered over-front of machine, swing lock engaged, and load restrained from swinging. Travel slowly and keep the lifted load as close to the ground as possible, and especially avoid any abrupt steering, accelerating or braking.
- Do not operate the crane while carrying the load.
- Creep is motion for crane not to travel more than 200' (60 m) in any 30 minutes period and to travel at the speed of less than 1 mph (1.6 km/h).
- For creep operation, set drive select switch to "4-WHEEL (LO)" and set gear shift lever to "1".
- The mass of the hook (195 lbs kg for 15 t capacity, 53 lbs for 2 t capacity), slings and all similarly used load handling devices must be considered as part of the load and must be deducted from the lifting capacities.
- For rated lifting capacity of single top, reduce 142 lbs from the rated lifting capacities of relevant boom according to a weight reduction for auxiliary load handling equipment. Capacities of single top shall not exceed 4,000 lbs (1,800 kg) including main hook.
- The lifting capacity data stowed in the Load Moment Indicator (AML-C) is based on the standard number of parts of line listed in the chart. Standard number of parts of line for on rubber operation should be according to the following table.

Boom length in Feet (meters)	17.4' (5.3 m)	30' (9.0 m)	42' (12.7 m)	Single top
Number of parts of line	4	4	4	1

WARNING AND OPERATING INSTRUCTIONS FOR LIFTING CAPACITIES

GENERAL

1. RATED LIFTING CAPACITIES apply only to the machine as originally manufactured and normally equipped by TADANO LTD. Modifications to the machine or use of optional equipment other than that specified can result in a reduction of capacity. Hydraulic cranes can be hazardous if improperly operated or maintained. Operation and maintenance of this machine must be in compliance with information in the **Operation and Maintenance Manual** supplied with the crane. If this manual is missing, order a replacement through the distributor.
3. The operator and other personnel associated with this machine shall fully acquaint themselves with the latest American National Standards Institute (ANSI) safety standards for cranes.

SET UP

1. Rated lifting capacities on the chart are the maximum allowable crane capacities and are based on the machine standing level on firm supporting surface under ideal job conditions. Depending on the nature of the supporting surface, it may be necessary to have structural supports under the outrigger floats or tires to spread the loads to a larger bearing surface.
2. For outrigger operation, outriggers shall be properly extended with tires free of supporting surface before operating crane.

OPERATION

1. Rated lifting capacities have been tested to and meet minimum requirements of SAE J1063-Cantilevered Boom Crane Structures Method of Test.
2. Rated lifting capacities do not exceed 85% of the tipping load on outriggers fully extended as determined by SAE J765-Crane Stability Test Code.
Rated lifting capacities for partially extended outriggers are determined from the formula, Rated Lifting Capacities=(Tipping Load - 0.1 x Tip Reaction)/1.25.
3. Rated lifting capacities above thick lines in the chart are based on crane strength and those below, on its stability. They are based on actual load radius increased by boom deflection.
4. The weight of handling device such as hook blocks (195 lbs for 15 t capacity, 53 lbs for 2 t capacity), slings, etc., must be considered as part of the load and must be deducted from the lifting capacities.
5. Rated lifting capacities are based on freely suspended loads and make no allowance for such factors as the effect of wind, sudden stopping of loads, supporting surface conditions, inflation of tires, operating speeds, side loads, etc. Side pull on the boom or jib is extremely dangerous. Such action can damage the boom, jib or slewing mechanism, and lead to overturning of the crane.
6. Rated lifting capacities do not account for wind on lifted load or boom. We recommend against working under the conditions that the load is out of control due to a strong wind. During boom lift, consider that the rated lifting capacity is reduced by 50% when the wind speed is 9 m/s to 12 m/s, reduced by 70 % when the wind speed is 12 m/s to 14 m/s. If the wind speed is 14 m/s or over, stop operation. During jib lift, stop operation if the wind speed is 9 m/s or over.
7. Rated lifting capacities at load radius shall not be exceeded. Do not tip the crane to determine allowable loads.
8. Do not operate at boom lengths, radii, or boom angles, where no capacities are shown. Crane may overturn without any load on the hook.
9. When boom length is between values listed, refer to the rated lifting capacities of the next longer and next shorter booms for the same radius. The lesser of the two rated lifting capacities shall be used.
10. When making lifts at a load radius not shown, use the next longer radius to determine allowable capacity.
11. Load per line should not exceed 4,000 lbs (1,800 kgf) for main winch and auxiliary winch.
12. Check the actual number of parts of line with Automatic Moment Limiter (AML-C) before operation. Maximum lifting capacity is restricted by the number of parts of line of Automatic Moment Limiter (AML-C). Limited capacity is as determined from the formula, Single line pull for main winch 4,000 lbs (1,800 kgf) x number of parts of line.
13. The boom angle before loading should be greater to account for deflection. For rated lifting capacities, the loaded boom angle and the load radius is for reference only.

14. The 17.4' (5.3 m) boom length capacities are based on boom fully retracted. If not fully retracted [less than 30' (9.0 m) boom length], use the rated lifting capacities for the 30' (9.0 m) boom length.
15. Extension or retraction of the boom with loads may be attempted within the limits of the RATED LIFTING CAPACITIES. The ability to telescope loads is limited by hydraulic pressure, boom angle, boom length, crane maintenance, etc.
16. For lifting capacity of single top, deduct the weight of the load handling equipment from the rated lifting capacity of the boom. For the lifting capacity of single top, the net capacity shall not exceed 4,000 lbs (1,800 kg) including the main boom hook mass attached to the boom.
17. When jib removing, jib state switch select removed.
18. When erecting and stowing jib, be sure to retain it by hand or by other means to prevent its free movement.
19. Use "ANTI-TWO-BLOCK DEVICE" disable switch when erecting and stowing jib and when stowing hook block. While the switch is pushed, the hoist does not stop, even when overwind condition occurs.
20. For boom length with 11.8' (3.6 m) Jib, rated lifting capacities are determined by loaded boom angle only in the column headed "78' (23.8 m) Boom + 11.8' (3.6 m) Jib".
For boom length with 18' (5.5 m) Jib, rated lifting capacities are determined by loaded boom angle only in the column headed "78' (23.8 m) Boom + 18' (5.5 m) Jib".
For angles not shown, use the next lower loaded boom angle to determine allowable capacity.
21. When lifting a load by using jib (aux. winch) and boom (main winch) simultaneously, do the following:
 - Enter the operation status as jib operation, not as boom operation.
 - Before starting operation, make sure that mass of load is within rated lifting capacity for jib.
22. The lifting capacity data stowed in the Load Moment Indicator (AML-C) is based on the standard number of parts of line listed in the chart. Standard number of parts of line for an outrigger operation should be according to the following table.

Boom length	17.4' (5.3 m)	30' to 78' (9.0 m to 23.8 m)	Single top/ jib
Number of parts of line	8	4	1

23. The lifting capacity for over side area differs depending on outrigger extension width. Work with capacity corresponding to the extension width. The lifting capacities for over front and over rear areas are for "outriggers fully extended". However, the areas (angle a) differ depending on the outrigger extension width.

Outriggers extended width	14'-1/4" (4.3 m) (middle)	11'-5-3/4" (3.5 m) (middle)	8'-2-3/8" (2.5 m) (middle)	5'-4-1/2" (1.64 m) (minimum)
Angle a°	70	60	55	50

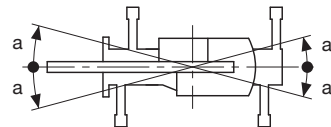

24. Be very careful not to come in contact with the mirror, engine cover, etc, with following warning messages. When operating crane in the following case.
 - When lowering the boom angles less than 12°.
 - When slewing with the boom angles less than 12°.

DEFINITIONS

1. Load Radius: Horizontal distance from a projection of the axis of rotation to supporting surface before loading to the center of the vertical hoist line or tackle with load applied.
2. Loaded Boom Angle: The angle between the boom base section and the horizontal, after lifting the rated lifting capacity at the load radius.
3. Working Area: Area measured in a circular arc about the centerline of rotation.
4. Freely Suspended Load: Load hanging free with no direct external force applied except by the hoist line.
5. Side Load: Horizontal side force applied to the lifted load either on the ground or in the air.

WARNING AND OPERATING INSTRUCTIONS FOR USING THE LOAD MOMENT INDICATOR (AML-C)

1. Set AML select keys in accordance with the actually operating crane conditions and don't fail to make sure, before crane operation, that the displays on front panel are correct.
 2. When operating crane on outriggers:
 - Before outrigger operation, suspension-lock in the over-front area of the boom. (Locking and releasing cannot be performed in other state.)
 - Keep pressing the switch to the "LOCK" side until the suspension-lock confirmation lamp changes from flashing to lighting, and lower the body to the full. (Outrigger operation and crane operation cannot be performed without suspension-locking.)
 - Set P.T.O. switch to "ON".
 - Press the outrigger state select key to register for the outrigger operation. If the display agrees with the actual state, press the set key to register. After the completion of the registration, the pop-up window closes.
 - Press the lift state select key to register the lift state to be used (single top / jib / boom).
 - Each time the lift state select key is pressed, the display changes. If the display agrees with the actual state, press the set key to register. After the completion of the registration, the pop-up window closes.
 - When erecting and stowing jib, select the status of jib set (Jib lift indicative symbol flickers).
 3. When operating crane on rubber:
 - Suspension-lock in the over-front area of the boom. (Locking and releasing cannot be performed in other state.)
 - Keep pressing the switch to the "LOCK" side until the suspension-lock confirmation lamp changes from flashing to lighting, and lower the body to the full. (Crane operation cannot be performed without suspension-locking.)
 - Set P.T.O. switch to "ON".
 - Press the outrigger state select key to register for the on rubber operation. Each time the outrigger state select key is pressed, the display changes. Select the creep operation, the on rubber state indicative symbol flickers.
 - Press the lift state select key to register the lift state.
- However, pay attention to the following.
- (1) For stationary operation.
 - The front capacities are attainable only when the over front position symbol comes on. When the boom is more than 2 degrees from centered over front of chassis, 360° capacities are in effect.
 - When a load is lifted in the front position and then slewed to the side area, make sure the value of the Load Moment Indicator (AML-C) is below the 360° lifting capacity.
 - (2) For creep operation.
 - The creep capacities are attainable only when boom is in the straight forward position of chassis and the over-front position symbol is on. If boom is not in the straight forward position of chassis, never lift load.
 4. This machine is equipped with an automatic slewing stop device. (For the details, see Operation and Maintenance Manual.) But, operate very carefully because the automatic slewing stop does not work in the following cases.
 - During on rubber operation.
 - When the "P.T.O" switch is set to "OVERRIDE" and the "OVERRIDE" key switch outside the cab is on.
 5. During crane operation, make sure that the displays on front panel are in accordance with actual operating conditions.
 6. The displayed values of Load Moment Indicator (AML-C) are based on freely suspended loads and make no allowance for such factors as the effect of wind, sudden stopping of loads, supporting surface conditions, inflation of tire, operating speed, side loads, etc. For safe operation, it is recommended when extending and lowering boom or slewing, lifting loads shall be appropriately reduced.
 7. Load Moment Indicator (AML-C) is intended as an aid to the operator. Under no condition should it be relied upon to replace use of capacity charts and operating instruction. Sole reliance upon Load Moment Indicator (AML-C) aids in place of good operating practice can cause an accident. The operator must exercise caution to assure safety.

GR-150XL Axle weight distribution chart

	Pounds			Kilograms		
	GVW	Front	Rear	GVW	Front	Rear
Basic machine	30,560	15,300	15,260	13,860	6,940	6,920
Remove: 1. 1.8 ton hook block and auxiliary lifting sheave (single top)	-120	-340	220	-53	-155	102
2. 2-stage jib (3.6 m, 5.5 m)	-410	-490	80	-185	-221	36



TADANO

TADANO LTD. (International Sales Division)

4-12, Kamezawa 2-chome,
Sumida-ku, Tokyo 130-0014, Japan

Tel: +81-(0)3-3621-7750

Fax: +81-(0)3-3621-7785

www.tadano.com

info@tadano.com

Printed in Japan
2021-05-1