

GT-300ER

(Right-hand drive, EURO3, AMT)
30 Ton Capacity

SPEC. SHEET NO. GT-300E-3-01201/EX-01

HYDRAULIC TRUCK CRANE

DIMENSIONS

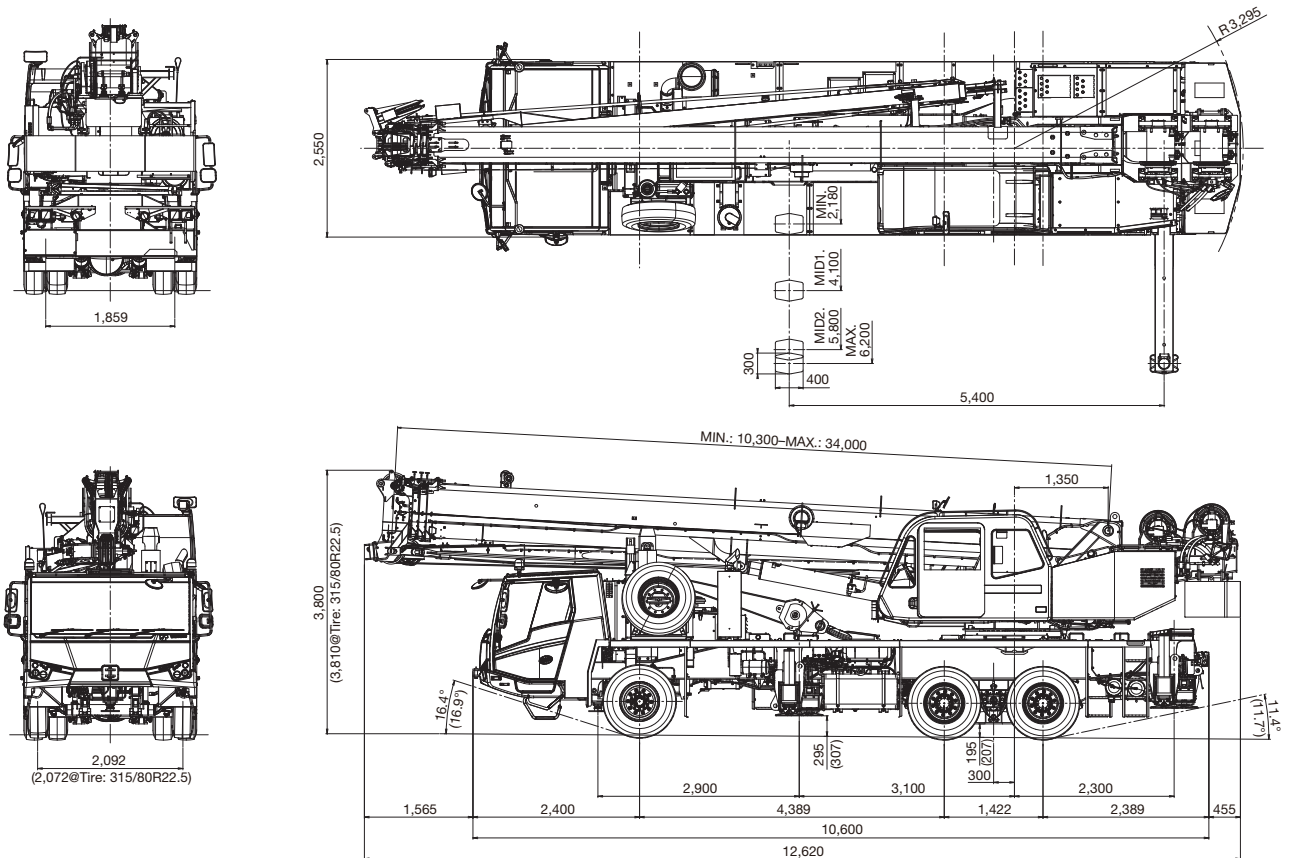

GENERAL DIMENSIONS

Turning radius	10.5 m
----------------	--------

Overall length	approx. 12,620 mm
Overall width	approx. 2,550 mm
Overall height	approx. 3,800 mm

CRANE SPECIFICATIONS

BOOM

4 section full power partially synchronized telescoping boom of round box construction with 3 sheaves at boom head. The synchronization system consists of 1 telescope cylinders, extension cables and retraction cables. Hydraulic cylinder fitted with holding valve. 2 easily removable wire rope guards, rope dead end provided on one side of boom head. Boom telescope sections are supported by wear pads both vertically and horizontally.

Fully retracted length.....	10.3 m
Fully extended length	34.0 m
Extension speed.....	23.7 m in 76 s
Root diameter.....	0.32 m

BOOM ELEVATION

By a double acting hydraulic cylinders with holding valve. Boom angle indicator.

Boom angle	-2.5°- 81°
Boom raising speed	20° to 60° in 24 s

JIB

2 stage boom extension with triple offset. Box type top section telescopes from box type base section. Stored under base boom section (under slung jib).

Length	8.5 m, 14 m
Offset.....	5°, 25°, 45°
Root diameter.....	0.32 m

AUXILIARY LIFTING SHEAVE (SINGLE TOP)

Single sheave mounted to main boom head for single line work(stowable).

Root diameter.....	0.32 m
--------------------	--------

ANTI-TWO-BLOCK DEVICE

Pendant type over-winding cut out device with audio-visual (FAILURE lamp/BUZZER) warning system.

SLEWING

Hydraulic axial piston motor driven through planetary slewing speed reducer. Continuous 360° full circle slewing on ball bearing.

Equipped with manually locked/released slewing brake. A positive slewing lock for travel modes, manually engaged in cab. Twin slewing system : Free slewing or lock slewing controlled by selector switch in cab.
Slewing speed..... 3.0 min⁻¹ {rpm}

WINCH

MAIN WINCH

Variable speed type with grooved drum driven by hydraulic axial piston motor through speed reducer. Power load lowering and raising. Equipped with automatic brake (neutral brake) and counterbalance valve. Controlled independently of auxiliary winch. Equipped with cable follower and drum rotation indicator.

MAIN DRUM

Root diameter x wide	0.32 m x 0.484 m
Wire rope diameter x length	16 mm x 190 m
Drum capacity	219.5 m, 6 layers
Maximum single line pull (1st layer).....	56.0 kN (5,710 kgf)
Maximum permissible linepull wire strength.....	55.1 kN (5,620 kgf)

AUXILIARY WINCH

Variable speed type with grooved drum driven by hydraulic axial piston motor through speed reducer. Power load lowering and raising. Equipped with automatic brake (neutral brake) and counterbalance valve. Controlled independently of main winch. Equipped with cable follower and drum rotation indicator.

AUXILIARY DRUM

Root diameter x wide	0.32 m x 0.484 m
Wire rope diameter x length	16 mm x 110 m
Drum capacity	219.5 m, 6 layers
Maximum single line pull (1st layer).....	56.0 kN (5,710 kgf)
Maximum permissible linepull wire strength.....	55.1 kN (5,620 kgf)

WIRE ROPE

Nuflex wire (no-spin), extra improved plow steel, preformed, independent wire rope core.
Main & Auxiliary 16 mm

HOOK BLOCKS

30 ton
(4 sheaves with swivel hook and safety latch, mass: approx. 270 kg)
4.5 ton
(Weighted hook with swivel and safety latch, mass: approx. 100 kg)

HYDRAULIC SYSTEM

PUMPS

2 variable piston pumps for crane functions. Tandem gear pump for, slewing and optional equipment. Powered by carrier engine. Pump disconnect for crane is engaged/disengaged by switch from driver's cab.

CONTROL VALVES

Multiple valves actuated by pilot pressure with integral pressure relief valves.

RESERVOIR

418 liters capacity. External sight level gauge.

FILTRATION

BETA10=10 return filter, full flow with bypass protection, located inside of hydraulic reservoir. Accessible for easy replacement.

OIL COOLER - Air cooled fan type.

CRANE CAB AND CONTROLS

Left side, 1 man type, steel construction with sliding door access and safety glass windows opening at side. Door window is powered control. Windshield glass window and roof glass window are shatter-resistant. Wiper and washer (front windshield and roof window). Tinted safety glass and sun visor. Adjustable control lever stands for slewing, boom elevating, boom telescoping, auxiliary winch and main winch. Control lever stands can change neutral positions and tilt for easy access to cab. Foot operated controls: boom telescoping boom elevating, and engine throttle. 3 way adjustable operator's seat with high back, headrest and armrest. Cab floor mat. Engine throttle knob. Hot water cab heater and air conditioning.

Dash-mounted engine start/stop, monitor lamps, cigarette lighter, power window switch, emergency engine stop switch, slewing brake switch, boom telescoping/auxiliary winch select switch, eco mode switch, and slewing free/ lock selector switch.

Instruments - Warning device (visual). Hydraulic oil pressure is monitored and displayed on the AML-C display panel.

COUNTERWEIGHT

Integral with slewing frame Mass... 3,200 kg

CRANE SPECIFICATIONS

TADANO Automatic Moment Limiter

(AML-C) including:

- Control lever lockout function with audible and visual pre-warning
- Number of parts of line
- Boom position indicator
- Outrigger state indicator
- Slewing angle
- Boom angle / boom length / jib offset angle / jib length / load radius / rated lifting capacities / actual loads read out
- Potential lifting height
- Ratio of actual load moment to rated load moment indication
- Permissible load
- Automatic Speed Reduction and Slow Stop function on slewing
- Working condition register switch
- Load radius / boom angle / tip height / slewing range preset function
- External warning lamp

- Tare function
- Main hydraulic oil pressure
- Fuel consumption monitor
- Main winch / auxiliary winch select
- Drum rotation indicator (audible and visible type) main and auxiliary winch

TADANO AML-C monitors outrigger extended length and automatically programs the corresponding "RATED LIFTING CAPACITIES" table

Operator's right hand console includes, slewing lock lever and sight level bubble.

Upper right console includes flood lamp switch, roof washer and wiper switch, emergency outrigger set up key switch, jib status switch, oil cooler switch, working light switch and air conditioning control switch.

NOTE: Each crane motion speed is based on unladen conditions.

CARRIER SPECIFICATIONS

TYPE

right-hand drive, 6x4.

FRAME

High tensile steel, all welded mono-box construction.

ENGINE

Model	Daimler OM926LA (EURO3)
Type	Direct injection diesel
No. of cylinders	6
Combustion	4 cycle, turbo charged and after cooled
Bore x Stroke, mm	106 x 136
Displacement, liters	7.20
Air inlet heater	24 volt preheat
Air cleaner	Dry type, replaceable element
Oil filter	Full flow with replaceable element
Fuel filter	Full flow with replaceable element
Fuel tank, liters	300, left side of carrier
Cooling	Liquid pressurized, recirculating by-pass
Radiator	Fin and tube core, thermostat controlled
Fan, mm	Suction type, 8-blade, 725 dia.
Starting	24 volt
Charging	24 volt system, negative ground
Battery	2-120 amp. Hour
Compressor, air, l /min	590 at 1,900 min ⁻¹
Output, Max. kW (HP)	Gross 240 (326) at 2,200 min ⁻¹
Torque, Max. Nm	1,300 at 1,200-1,600 min ⁻¹
Capacity, liters	
Cooling water	10
Lubrication	24-29
Fuel	300

TRANSMISSION

Model	ZF TraXon 12TX 2615 SO
Type	Automatic mechanical transmission, electro-pneumatically operated dry-type clutch and automatic gear shifting with 12 forward gears and 2 reverse gears.

TRAVEL SPEED

85 km/h

GRADEABILITY (tan θ)

68% (65% at 315/80R22.5TIRE)

AXLE

1st: Reverse-elliot type, steering axle.

2nd, 3rd: Full floating type, driving axle inter-wheel and inter-axle differential lock.

STEERING

ZF Servocom. mechanical hydraulically-assisted of front axle.

SUSPENSION

Front: Leaf springs. Double acting shock absorbers.

Rear: hendrickson ULTIMAAX, Rubber mounted tandem with walking beam.

BRAKE SYSTEMS

Service: Dual circuit compressed air system

Parking: Spring loaded type on 2nd and 3rd axles.

Auxiliary: Engine exhaust brake and constant throttle engine brake.

TIRES - 295/80R22.5 Air pressure: 850 kPa
(315/80R22.5 Air pressure: 850 kPa)

OUTRIGGERS

Hydraulically operated H-type outriggers.

Vertical jack cylinders equipped with integral holding valve.

Each outrigger beam and jack is controlled independently.

Outrigger jack floats are attached thus eliminating the need of manually attaching and detaching them. Controls and sight bubble located either side of carrier. 4 outrigger extension lengths are provided with corresponding "RATED LIFTING CAPACITIES" for crane duty in confined areas.

Min. Extension	2.18 m center to center
Mid. Extension	4.1 m center to center
Mid. Extension	5.8 m center to center
Max. Extension	6.2 m center to center
Float size	0.4 m x 0.3 m

FRONT JACK

A fifth hydraulically operated outrigger jack. Mounted to the front frame of carrier to permit 360° lifting capabilities.

Hydraulic cylinder fitted with pilot check valve.

Float size (Diameter)..... 0.26 m

CARRIER CAB

Two man full width cab of composite (steel sheet metal and fiber-glass) structure, with safety glass, air-cushioned seats, driver's seat offering various adjustment options, with memory function, engine dependent water heater, air conditioning, multifunction display and Cruise Control.

STANDARD EQUIPMENT

- Telematics (machine data logging and monitoring system) with - HELLO-NET via internet (availability depends on countries)
- Eco mode system
- Transmission neutral position engine start
- Tilt-telescope steering wheel
- Air dryer
- Water separator with filter (high filtration)
- Air cleaner dust indicator
- Tire inflation kit
- Front fog lamp
- Full instrumentation package
- Towing hooks-Front and rear
- Lifting eyes
- Weighted hook storage compartment
- Winch drum mirror
- Tool storage compartment
- Over unwinding prevention

OPTIONAL EQUIPMENT

- Wind speed indicator
- Beacon lamp
- Winch drum camera
- ABS
- 315/80R22.5Tire (Comply with Australian regulation)
- Side marker lamp
- Rear fog lamp
- Rear view camera
- Spare tire and bracket
- Stepladder (capacity 100 kg)

HOISTING PERFORMANCE

LINE SPEEDS AND PULLS

Layer	Main or auxiliary winch - 0.32 m drum	
	Line speeds ¹	Line pulls Available ²
	m/min	kN (kgf)
1st	106	56.0 (5,710)
2nd	115	51.1 (5,210)
3rd	124	46.7 (4,760)
4th	132	43.1 (4,400)
5th	141	40.0 (4,080)
6th ³	150	37.3 (3,800)

- Maximum permissible line pull wire strength.
Main & Auxiliary: 55.1 kN (5,620 kgf)
- Maximum lifting per line.
Main & Auxiliary: 44.1 kN (4,500 kgf)

- ¹ Line speed based only on hook block, not loaded.
- ² Developed by machinery with each layer of wire rope, but not based on rope strength or other limitations in machinery or equipment.
- ³ Sixth layer of wire rope are not recommended for hoisting operations.

DRUM WIRE ROPE CAPACITIES

Wire rope layer	Main drum grooved lagging 16 mm wire rope	
	Rope per layer	Total wire rope
	m	m
1	30.1	30.1
2	32.8	62.9
3	35.3	98.2
4	37.8	136.0
5	40.5	176.5
6	43.0	219.5

DRUM DIMENSIONS

Root diameter	320 mm
Length	484 mm
Flange diameter	530 mm

GT-300ER WORKING RANGE CHART

BOOM

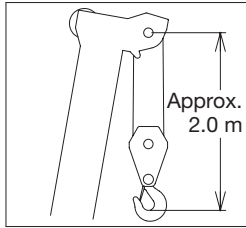

SINGLE TOP

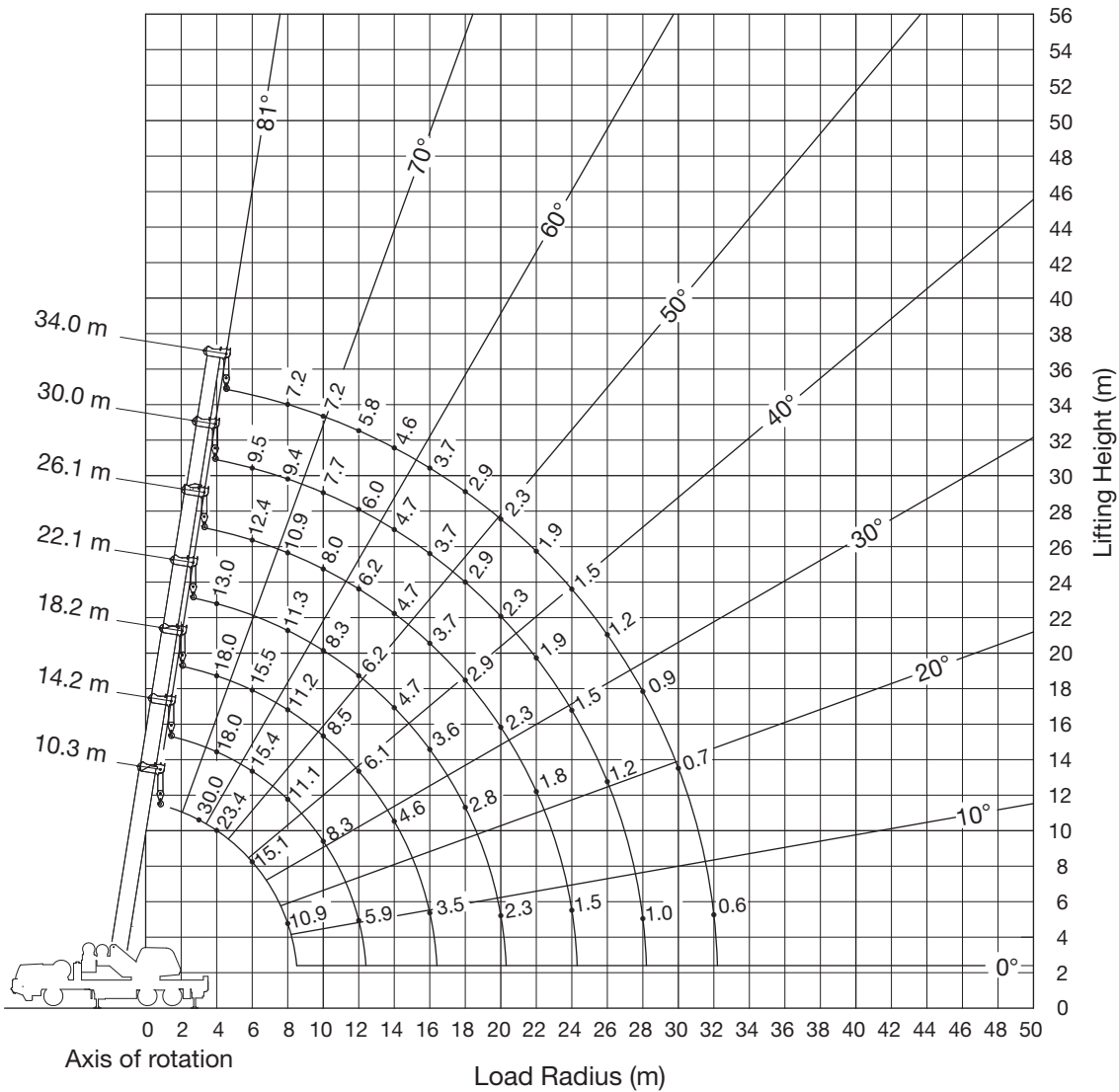
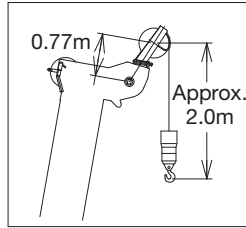

NOTE: Lifting height shows a calculated value.

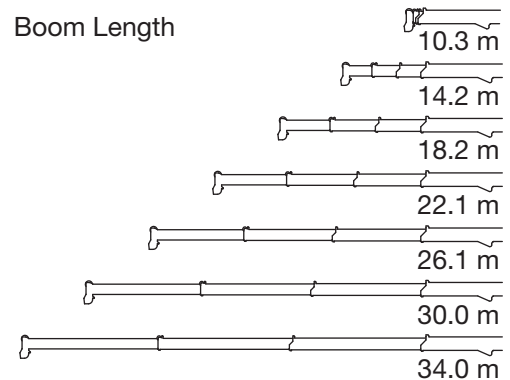

GT-300ER WORKING RANGE CHART

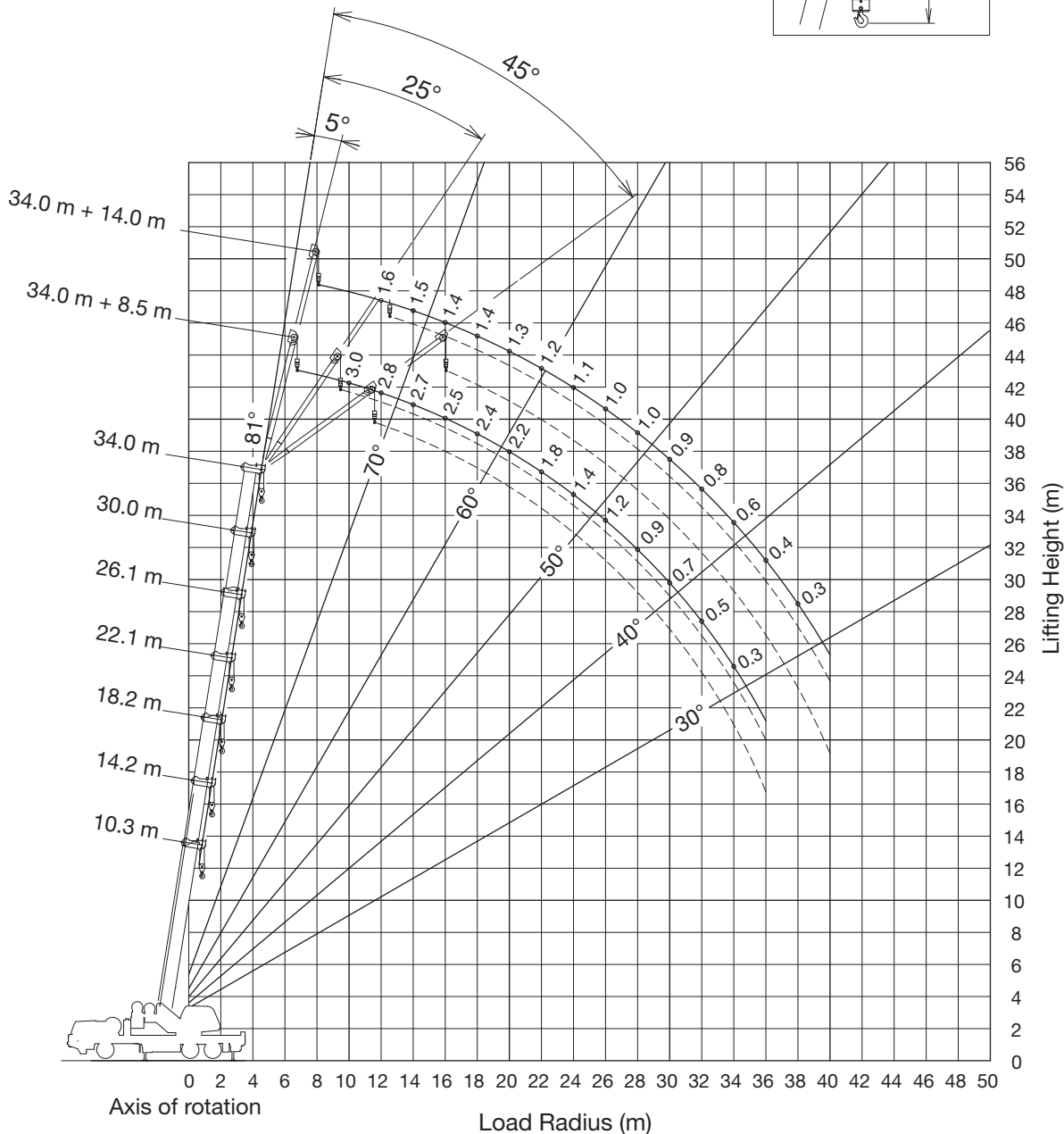
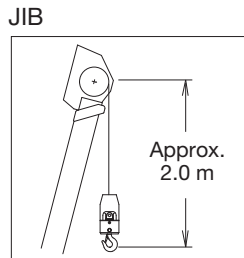

NOTE: Lifting height shows a calculated value.

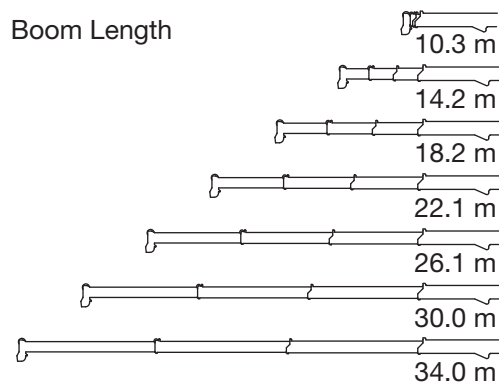

GT-300ER RATED LIFTING CAPACITIES

ON OUTRIGGERS FULLY EXTENDED 6.2 m SPREAD 360° ROTATION (Unit: x 1,000 kg)							
B \ A	10.3	14.2	18.2	22.1	26.1	30.0	34.0
2.5	30.0	18.0					
3.0	30.0	18.0	18.0				
3.5	26.9	18.0	18.0				
4.0	23.4	18.0	18.0	13.0			
4.5	20.7	18.0	18.0	13.0	13.0		
5.0	18.5	18.0	18.0	13.0	13.0		
5.5	16.7	16.9	17.0	13.0	12.7	9.5	
6.0	15.1	15.4	15.5	13.0	12.4	9.5	
6.5	13.8	14.1	14.2	13.0	12.1	9.5	7.2
7.0	12.7	13.0	13.1	13.0	11.9	9.5	7.2
8.0	10.9	11.1	11.2	11.3	10.9	9.4	7.2
9.0		9.7	9.8	9.7	9.3	8.9	7.2
10.0		8.3	8.5	8.3	8.0	7.7	7.2
12.0		5.9	6.1	6.2	6.2	6.0	5.8
14.0			4.6	4.7	4.7	4.7	4.6
16.0			3.5	3.6	3.7	3.7	3.7
18.0				2.8	2.9	2.9	2.9
20.0				2.3	2.3	2.3	2.3
22.0					1.8	1.9	1.9
24.0					1.5	1.5	1.5
26.0						1.2	1.2
28.0						1.0	0.9
30.0							0.7
32.0							0.6
Number of parts of line	8	6	6	4	4	4	4

ON OUTRIGGERS MIDDLE EXTENDED 5.8 m SPREAD 360° ROTATION (Unit: x 1,000 kg)							
B \ A	10.3	14.2	18.2	22.1	26.1	30.0	34.0
2.5	30.0	18.0					
3.0	26.6	18.0	18.0				
3.5	23.3	18.0	18.0				
4.0	20.6	18.0	18.0	13.0			
4.5	18.3	18.0	18.0	13.0	13.0		
5.0	16.5	16.7	16.8	13.0	13.0		
5.5	14.9	15.1	15.2	13.0	12.7	9.5	
6.0	13.5	13.8	13.9	13.0	12.4	9.5	
6.5	12.4	12.6	12.7	12.8	12.1	9.5	7.2
7.0	11.4	11.6	11.7	11.8	11.8	9.5	7.2
8.0	9.7	10.0	10.1	10.2	9.8	9.4	7.2
9.0		8.6	8.7	8.7	8.4	8.0	7.2
10.0		7.3	7.4	7.5	7.2	7.0	6.7
12.0		5.1	5.3	5.4	5.4	5.4	5.2
14.0			3.9	4.0	4.1	4.1	4.0
16.0			3.0	3.1	3.1	3.2	3.2
18.0				2.4	2.4	2.5	2.5
20.0				1.9	1.9	1.9	2.0
22.0					1.5	1.5	1.5
24.0					1.2	1.2	1.2
26.0						0.9	0.9
28.0						0.7	0.7
30.0							0.5
Number of parts of line	8	6	6	4	4	4	4

A: Boom length (m)
B: Load radius (m)

GT-300ER RATED LIFTING CAPACITIES

ON OUTRIGGERS MIDDLE EXTENDED 4.1 m SPREAD 360° ROTATION (Unit: x 1,000 kg)							
B \ A	10.3	14.2	18.2	22.1	26.1	30.0	34.0
2.5	27.1	18.0					
3.0	23.0	18.0	18.0				
3.5	19.9	18.0	18.0				
4.0	17.4	17.7	16.3	13.0			
4.5	15.4	15.2	14.0	13.0	12.1		
5.0	13.7	13.1	12.2	11.4	10.7		
5.5	12.0	11.4	10.7	10.1	9.5	8.9	
6.0	10.2	10.0	9.5	9.0	8.5	8.1	
6.5	8.8	8.9	8.5	8.1	7.7	7.3	6.9
7.0	7.6	8.0	7.7	7.3	7.0	6.7	6.3
8.0	5.9	6.2	6.3	6.1	5.8	5.6	5.3
9.0		5.0	5.1	5.1	5.0	4.8	4.6
10.0		4.1	4.2	4.3	4.2	4.1	3.9
12.0		2.8	2.9	3.0	3.1	3.0	2.9
14.0			2.0	2.1	2.2	2.2	2.1
16.0			1.4	1.5	1.6	1.6	1.6
18.0				1.1	1.1	1.1	1.1
20.0				0.7	0.8	0.8	0.8
22.0					0.5	0.5	0.5
Number of parts of line	8	6	6	4	4	4	4

ON OUTRIGGERS MINIMUM EXTENDED 2.18 m SPREAD 360° ROTATION (Unit: x 1,000 kg)							
B \ A	10.3	14.2	18.2	22.1	26.1	30.0	34.0
2.5	14.2	12.7					
3.0	11.2	10.3	9.4				
3.5	9.1	8.5	7.9				
4.0	7.5	7.1	6.7	6.3			
4.5	6.3	6.1	5.8	5.4	5.1		
5.0	5.4	5.2	5.0	4.7	4.5		
5.5	4.5	4.5	4.4	4.2	4.0	3.7	
6.0	3.8	4.0	3.8	3.7	3.5	3.3	
6.5	3.2	3.5	3.4	3.3	3.1	3.0	2.8
7.0	2.7	3.0	3.0	2.9	2.8	2.6	2.5
8.0	1.9	2.2	2.3	2.3	2.2	2.1	2.0
9.0		1.6	1.8	1.8	1.7	1.7	1.5
10.0		1.2	1.3	1.4	1.4	1.3	1.2
12.0		0.5	0.6	0.8	0.8	0.7	0.6
Number of parts of line	8	6	6	4	4	4	4

A: Boom length (m)
B: Load radius (m)

GT-300ER RATED LIFTING CAPACITIES

ON OUTRIGGERS FULLY EXTENDED 6.2 m SPREAD 360° ROTATION (Unit: x 1,000 kg)							
B	34.0-m Boom + 8.5-m Jib			B	34.0-m Boom + 14.0-m Jib		
	5° Offset	25° Offset	45° Offset		5° Offset	25° Offset	45° Offset
8				8			
9	3.0			9			
10	3.0			10			
12	2.8	2.7		12	1.6		
14	2.7	2.5	1.5	14	1.5		
16	2.5	2.3	1.5	16	1.4	1.0	
18	2.4	2.2	1.4	18	1.4	1.0	
20	2.2	2.0	1.4	20	1.3	0.9	0.7
22	1.8	1.9	1.3	22	1.2	0.9	0.7
24	1.4	1.6	1.3	24	1.1	0.8	0.7
26	1.2	1.3	1.3	26	1.0	0.8	0.7
28	0.9	1.0	1.1	28	1.0	0.7	0.6
30	0.7	0.8	0.9	30	0.9	0.7	0.6
32	0.5	0.6		32	0.7	0.7	0.6
34	0.3	0.4		34	0.6	0.7	0.6
36				36	0.4	0.5	0.6
38				38	0.3	0.4	
40				40		0.3	

ON OUTRIGGERS MIDDLE EXTENDED 5.8 m SPREAD 360° ROTATION (Unit: x 1,000 kg)							
B	34.0-m Boom + 8.5-m Jib			B	34.0-m Boom + 14.0-m Jib		
	5° Offset	25° Offset	45° Offset		5° Offset	25° Offset	45° Offset
8				8			
9	3.0			9			
10	3.0			10			
12	2.3	2.7		12	1.6		
14	1.7	2.1	1.5	14	1.5		
16	1.2	1.5	1.5	16	1.4	1.0	
18	0.8	1.1	1.4	18	1.0	1.0	
20	0.5	0.8	1.0	20	0.7	0.9	0.7
22	0.3	0.5	0.7	22	0.5	0.8	0.7
24		0.3	0.5	24	0.3	0.6	0.7
26				26		0.4	0.6
28				28			0.4
30				30			0.3
32				32			
34				34			
36				36			
38				38			
40				40			

ON OUTRIGGERS MIDDLE EXTENDED 4.1 m SPREAD 360° ROTATION (Unit: x 1,000 kg)							
B	34.0-m Boom + 8.5-m Jib			B	34.0-m Boom + 14.0-m Jib		
	5° Offset	25° Offset	45° Offset		5° Offset	25° Offset	45° Offset
8				8			
9	3.0			9			
10	3.0			10			
12	2.8	2.7		12	1.6		
14	2.7	2.5	1.5	14	1.5		
16	2.5	2.3	1.5	16	1.4	1.0	
18	2.2	2.2	1.4	18	1.4	1.0	
20	1.7	2.0	1.4	20	1.3	0.9	0.7
22	1.4	1.6	1.3	22	1.2	0.9	0.7
24	1.1	1.3	1.3	24	1.1	0.8	0.7
26	0.8	1.0	1.1	26	1.0	0.8	0.7
28	0.6	0.8	0.8	28	0.8	0.7	0.6
30	0.4	0.5	0.6	30	0.6	0.7	0.6
32	0.3	0.3		32	0.5	0.7	0.6
34				34	0.3	0.5	0.6
36				36		0.3	0.4
38				38			
40				40			

B: Load radius (m)

GT-300ER RATED LIFTING CAPACITIES

ON OUTRIGGERS FULLY EXTENDED 6.2 m SPREAD 360° ROTATION (Unit: x 1,000 kg)							
B	30.0-m Boom + 8.5-m Jib			B	30.0-m Boom + 14.0-m Jib		
	5° Offset	25° Offset	45° Offset		5° Offset	25° Offset	45° Offset
8	3.3			8			
9	3.3			9			
10	3.3			10	1.8		
12	3.3	2.6		12	1.7		
14	3.1	2.4	1.5	14	1.6	1.1	
16	2.9	2.3	1.4	16	1.5	1.0	
18	2.7	2.1	1.4	18	1.3	0.9	0.7
20	2.3	2.0	1.3	20	1.2	0.9	0.7
22	1.9	1.9	1.3	22	1.1	0.8	0.7
24	1.5	1.7	1.3	24	1.0	0.8	0.7
26	1.2	1.4	1.3	26	1.0	0.8	0.7
28	1.0	1.1	1.1	28	0.9	0.7	0.6
30	0.7	0.8		30	0.9	0.7	0.6
32	0.5	0.6		32	0.8	0.7	0.6
34	0.4	0.4		34	0.6	0.6	0.6
36				36	0.5	0.6	
38				38	0.3	0.4	
40				40		0.3	

ON OUTRIGGERS MIDDLE EXTENDED 5.8 m SPREAD 360° ROTATION (Unit: x 1,000 kg)							
B	30.0-m Boom + 8.5-m Jib			B	30.0-m Boom + 14.0-m Jib		
	5° Offset	25° Offset	45° Offset		5° Offset	25° Offset	45° Offset
8	3.3			8			
9	3.3			9			
10	3.3			10	1.8		
12	2.6	2.6		12	1.7		
14	1.9	2.3	1.5	14	1.6	1.1	
16	1.4	1.7	1.4	16	1.5	1.0	
18	1.0	1.3	1.4	18	1.2	0.9	0.7
20	0.7	0.9	1.1	20	0.9	0.9	0.7
22	0.4	0.6	0.8	22	0.6	0.8	0.7
24		0.4	0.5	24	0.4	0.7	0.7
26			0.3	26	0.3	0.5	0.7
28				28		0.3	0.5
30				30			0.3
32				32			
34				34			
36				36			
38				38			
40				40			

ON OUTRIGGERS MIDDLE EXTENDED 4.1 m SPREAD 360° ROTATION (Unit: x 1,000 kg)							
B	30.0-m Boom + 8.5-m Jib			B	30.0-m Boom + 14.0-m Jib		
	5° Offset	25° Offset	45° Offset		5° Offset	25° Offset	45° Offset
8	3.3			8			
9	3.3			9			
10	3.3			10	1.8		
12	3.3	2.6		12	1.7		
14	3.1	2.4	1.5	14	1.6	1.1	
16	2.9	2.3	1.4	16	1.5	1.0	
18	2.4	2.1	1.4	18	1.3	0.9	0.7
20	1.9	2.0	1.3	20	1.2	0.9	0.7
22	1.5	1.7	1.3	22	1.1	0.8	0.7
24	1.2	1.4	1.3	24	1.0	0.8	0.7
26	0.9	1.0	1.1	26	1.0	0.8	0.7
28	0.7	0.8	0.8	28	0.9	0.7	0.6
30	0.5	0.5		30	0.7	0.7	0.6
32	0.3	0.3		32	0.6	0.7	0.6
34				34	0.4	0.5	0.6
36				36	0.3	0.4	
38				38			
40				40			

B: Load radius (m)

GT-300ER RATED LIFTING CAPACITIES

ON OUTRIGGERS FULLY EXTENDED 6.2 m SPREAD 360° ROTATION (Unit: x 1,000 kg)							
B	26.1-m Boom + 8.5-m Jib			B	26.1-m Boom + 14.0-m Jib		
	5° Offset	25° Offset	45° Offset		5° Offset	25° Offset	45° Offset
8	4.0			8			
9	4.0			9	1.9		
10	4.0			10	1.9		
12	3.7	2.8	1.6	12	1.7		
14	3.5	2.4	1.5	14	1.6	1.1	
16	3.2	2.2	1.4	16	1.4	1.0	
18	2.9	2.1	1.4	18	1.3	0.9	0.7
20	2.5	1.9	1.3	20	1.2	0.9	0.7
22	2.0	1.8	1.3	22	1.1	0.8	0.7
24	1.6	1.7	1.3	24	1.0	0.8	0.7
26	1.3	1.4	1.3	26	0.9	0.7	0.6
28	1.0	1.1		28	0.9	0.7	0.6
30	0.8	0.8		30	0.8	0.7	0.6
32	0.6			32	0.8	0.7	
34				34	0.7	0.6	
36				36	0.5	0.6	
38				38	0.4		

ON OUTRIGGERS MIDDLE EXTENDED 5.8 m SPREAD 360° ROTATION (Unit: x 1,000 kg)							
B	26.1-m Boom + 8.5-m Jib			B	26.1-m Boom + 14.0-m Jib		
	5° Offset	25° Offset	45° Offset		5° Offset	25° Offset	45° Offset
8	4.0			8			
9	4.0			9	1.9		
10	3.9	2.8		10	1.9		
12	2.8	2.6	1.6	12	1.7		
14	2.1	2.4	1.5	14	1.6	1.1	
16	1.5	1.8	1.4	16	1.4	1.0	
18	1.1	1.4	1.4	18	1.3	0.9	0.7
20	0.8	1.0	1.2	20	1.0	0.9	0.7
22	0.6	0.7	0.8	22	0.8	0.8	0.7
24	0.3	0.4	0.5	24	0.6	0.8	0.7
26			0.3	26	0.4	0.6	0.6
28				28		0.4	0.5
30				30			0.3
32				32			
34				34			
36				36			
38				38			

ON OUTRIGGERS MIDDLE EXTENDED 4.1 m SPREAD 360° ROTATION (Unit: x 1,000 kg)							
B	26.1-m Boom + 8.5-m Jib			B	26.1-m Boom + 14.0-m Jib		
	5° Offset	25° Offset	45° Offset		5° Offset	25° Offset	45° Offset
8				8	4.0		
9	1.9			9	4.0		
10	1.9			10	4.0	2.8	
12	1.7			12	3.7	2.6	1.6
14	1.6	1.1		14	3.5	2.4	1.5
16	1.4	1.0		16	3.1	2.2	1.4
18	1.3	0.9	0.7	18	2.5	2.1	1.4
20	1.2	0.9	0.7	20	2.0	1.9	1.3
22	1.1	0.8	0.7	22	1.6	1.7	1.3
24	1.0	0.8	0.7	24	1.2	1.4	1.3
26	0.9	0.7	0.6	26	0.9	1.1	1.1
28	0.9	0.7	0.6	28	0.7	0.8	
30	0.8	0.7	0.6	30	0.5	0.6	
32	0.6	0.7		32	0.3		
34	0.5	0.5		34			
36	0.3	0.4		36			
38				38			

B: Load radius (m)

WARNING AND OPERATING INSTRUCTIONS FOR LIFTING CAPACITIES

GENERAL

1. RATED LIFTING CAPACITIES apply only to the machine as originally manufactured and normally equipped by TADANO LTD. Modifications to the machine or use of optional equipment other than that specified can result in a reduction of capacity.
2. Hydraulic cranes can be hazardous if improperly operated or maintained. Operation and maintenance of this machine must be in compliance with information in the **Operation and Maintenance Manual** supplied with the crane. If this manual is missing, order a replacement through the distributor.

SET UP

1. Rated lifting capacities on the chart are the maximum allowable crane capacities and are based on the machine standing level on firm supporting surface under ideal job conditions. Depending on the nature of the supporting surface, it may be necessary to have structural supports under the outrigger floats to spread the loads to a larger bearing surface.
2. For outrigger operation, outriggers shall be properly extended with tires free of supporting surface before operating crane.

OPERATION

1. Rated lifting capacities on outriggers fully extended as determined by ISO4305.
2. Rated lifting capacities are based on actual load radius increased by boom deflection.
3. The weight of handling device such as hook blocks (270 kg for 30 t capacity, 100 kg for 4.5 t capacity), slings, etc., must be considered as part of the load and must be deducted from the lifting capacities.
4. Rated lifting capacities are based on freely suspended loads and make no allowance for such factors as the effect of wind, sudden stopping of loads, supporting surface conditions, operating speeds, side loads, etc. Side pull on the boom or jib is extremely dangerous. Such action can damage the boom, jib or slewing mechanism, and lead to overturning of the crane.
5. Rated lifting capacities do not account for wind on lifted load or boom. We recommend against working under the conditions that the load is out of control due to a strong wind. During boom lift, consider that the rated lifting capacity is reduced by 50% when the wind speed is 9 m/s to 12 m/s; reduced by 70 % when the wind speed is 12 m/s to 14 m/s. If the wind speed is 14 m/s or over, stop operation. During jib lift, stop operation if the wind speed is 9 m/s or over.
6. Rated lifting capacities at load radius shall not be exceeded. Do not tip the crane to determine allowable loads.
7. Do not operate at boom lengths, radii or boom angles, where no capacities are shown. Crane may overturn without any load on the hook.
8. When boom length is between values listed, refer to the rated lifting capacities of the next longer and next shorter booms for the same radius. The lesser of the two rated lifting capacities shall be used.
9. When making lifts at a load radius not shown, use the next longer radius to determine allowable capacity.
10. Load per line should not exceed 44.1 kN (4,500 kgf) for main winch and auxiliary winch.
11. Check the actual number of parts of line with Automatic Moment Limiter (AML-C) before operation. Maximum lifting capacity is restricted by the number of parts of line of Automatic Moment Limiter (AML-C). Limited capacity is as determined from the formula, Single line pull for main winch 44.1 kN (4,500 kgf) x number of parts of line.
12. The boom angle before loading should be greater to account for deflection. For rated lifting capacities, the loaded boom angle and the load radius is for reference only.
13. The 10.3-m Boom length capacities are based on boom fully retracted.

14. Extension or retraction of the boom with loads may be attempted within the limits of the RATED LIFTING CAPACITIES. The ability to telescope loads is limited by hydraulic pressure, boom angle, boom length, crane maintenance, etc.
15. For lifting capacity of single top, deduct the weight of the load handling equipment from the rated lifting capacity of the boom. For the lifting capacity of single top, the net capacity shall not exceed 4,500 kg including the main boom hook mass attached to the boom.
16. When a jib is removed, set the jib state switch to the REMOVED position.
17. Use "ANTI-TWO-BLOCK DEVICE" disable switch when erecting and stowing jib and when stowing hook block. While the switch is pushed, the hoist does not stop, even when overwind condition occurs.
18. When lifting a load by using jib (aux. winch) and boom (main winch) simultaneously, do the following:
 - Enter the operation status as jib operation, not as boom operation.
 - Before starting operation, make sure that mass of load is within rated lifting capacity for jib.
19. The lifting capacity data stowed in the Automatic Moment Limiter (AML-C) is based on the standard number of parts of line listed in the chart. Standard number of parts of line for on outrigger operation should be according to the following table.

Boom length	10.3 m	14.2 to 18.2 m	18.2 to 34 m	Single top/ jib
Number of parts of line	8	6	4	1

20. The lifting capacity differ depending on the outrigger extension width and slewing position. Work with capacity corresponding to the outrigger extension width and slewing position. For relationship between outrigger extension width, slewing position and lifting capacities, refer to the working area charts.

DEFINITIONS

1. Load Radius: Horizontal distance from a projection of the axis of rotation to supporting surface before loading to the center of the vertical hoist line or tackle with load applied.
2. Loaded Boom Angle: The angle between the boom base section and the horizontal, after lifting the rated lifting capacity at the load radius.
3. Working Area: Area measured in a circular arc about the centerline of rotation.
4. Freely Suspended Load: Load hanging free with no direct external force applied except by the hoist line.
5. Side Load: Horizontal side force applied to the lifted load either on the ground or in the air.

WARNING AND OPERATING INSTRUCTIONS FOR USING THE AUTOMATIC MOMENT LIMITER (AML-C)

- Set AML select keys in accordance with the actually operating crane conditions and don't fail to make sure, before crane operation, that the displays on front panel are correct.
- When operating crane on outriggers:
 - Set P.T.O. switch to "ON".
 - Press the outrigger state select key to register for the outrigger operation. If the display agrees with the actual state, press the set key to register. After the completion of the registration, the pop-up window closes.
 - Press the lift state select key to register the lift state to be used (single top / jib / boom).
 - Each time the lift state select key is pressed, the display changes. If the display agrees with the actual state, press the set key to register. After the completion of the registration, the pop-up window closes.
 - When erecting and stowing jib, select the status of jib set (Jib lift indicative symbol flickers).
- This machine is equipped with an automatic slewing stop device.
(For the details, see Operation and Maintenance Manual.)
- During crane operation, make sure that the displays on front panel are in accordance with actual operating conditions.
- The displayed values of AUTOMATIC MOMENT LIMITER (AML-C) are based on freely suspended loads and make no allowance for such factors as the effect of wind, sudden stopping of loads, supporting surface conditions, operating speed, side loads, etc.
For safe operation, it is recommended when extending and lowering boom or slewing, lifting loads shall be appropriately reduced.
- AUTOMATIC MOMENT LIMITER (AML-C) is intended as an aid to the operator. Under no condition should it be relied upon to replace use of capacity charts and operating instruction. Sole reliance upon AUTOMATIC MOMENT LIMITER (AML-C) aids in place of good operating practice can cause an accident. The operator must exercise caution to assure safety.

GT-300ER AXLE WEIGHT DISTRIBUTION CHART

	Kilograms			
	GVW	Front	Rear	
Basic machine	29,320	6,750	22,570	
Remove:				
1. 30 ton hook block	-270	-140	-130	
2. 4.5 ton hook block	-100	-100	0	
3. 2-stage jib (8.5 m, 14 m)	-725	-540	-185	
4. Single top	-50	-85	35	
5. Counter weight	-3,200	1,970	-5,170	
6. 2 persons (driver & passenger)	-150	-210	60	
Add:				
1. Spare tire (OPT.)	123	109	14	
2. Stepladder (OPT.)	5	0	5	
3. 295/80R22.5 change to 315/80R22.5 tires	200	40	160	
Permissible axle load				
	(295/80R22.5)	31,313	7,313	24,000
	(315/80R22.5)	32,000	8,000	24,000



TADANO

TADANO LTD. (International Sales Division)

KANDA SQUARE 18th Floor,
2-2-1 Kanda-Nishikicho,
Chiyoda-ku, Tokyo 101-0054, Japan

Phone : +81-3-6811-7309

[URL](http://www.tadano.com) www.tadano.com

[E-mail](mailto:info@tadano.com) info@tadano.com

Printed in Japan
2022-02-1